

TECHNICAL DATA

CAUTION

1. READ THIS MANUAL CAREFULLY TO
DIAGNOSE TROUBLE CORRECTLY
BEFORE OFFERING SERVICE.
2. THIS MANUAL IS USED BY QUALIFIED
APPLIANCE TECHNICIANS ONLY.
3. HAIER DOES NOT ASSUME ANY
RESPONSIBILITY FOR PROPERTY
DAMAGE OR PERSONAL INJURY FOR
IMPROPER
SERVICE PROCEDURES DONE BY ONE
UNQUALIFIED PERSON.

ON/OFF

Wall mounted Type E-Series

HSU-07LEA03
HSU-09LEA03
HSU-12LEA03

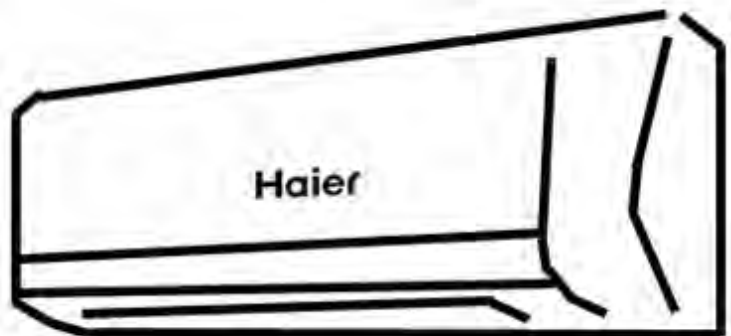

Большая библиотека технической документации

<https://splitsystema48.ru/instrukcii-po-ekspluatácii-kondicionerov.html>

каталоги, инструкции, сервисные мануалы, схемы.

Table of Contents

1. Features	2
2. Specifications	3
3. Remote controller lists	6
4. Sensors lists	6
5. Dimensional drawings	7
6. Operation range	9
7. Piping diagrams	10
8. Wiring diagrams	11
9. Capacity diagrams and curves diagrams	15
10. Sound level	30
11. Accessories	32
12. Control systems	33
13. Center of gravity	34
14. Installations	35

1 Features



Healthy negative ion: make your room full of an abundance natural negative ions



DRY function: Make dehumidifying in the room when the unit is working in the "DRY" mode .



ESF filter :Trap harmful dust and remove unpleasant odors effectively



Anti-mold filter: Catches most small particles and remove unpleasant odors effectively



Sleep mode: The setting temperature and the indoor noise can be adjusted to a more

comfortable level when you set the "sleep mode" during night sleep



24 Hour timer: Use the timer function to set on, or off, or from on to off, or from off to on



Auto restart: The function permits automatic return to previous operation conditions



Easy clean design: The panel is easy to wash and the airflow vents can be detached without

any special tools for quick cleaning of the inside of the air conditioner



Auto mode : According to the fixed temperature "26 °C", the unit will adjust

the operation mode automatically.



7K/9K



12K

2 Specifications

This information was not available at the time of publication .

NOMINAL CAPACITY and NOMINAL INPUT						
For indoor units only:						
INDOOR UNITS				HSU-07LEA03	HSU-09LEA03	HSU-12LEA03
NOMINAL INPUT	Cooling	nominal	kW	0.853	0.95	1.25

NOMINAL CAPACITY and						
Model				HSU-07LEA03	HSU-09LEA03	HSU-12LEA03
NOMINAL CAPACITY(3-4)	Cooling	norm.	kw	2.38	2.50	3.5
NOMINAL INPUT	Cooling	norm	kw	0.853	0.95	1.25
EER	Cooling			2.79	2.63	2.80
ENERGY LABEL(7-8)	Cooling			----	----	----
ANNUAL ENERGY CONSUMPTION(9)	Cooling		kwh	426.5	475	625

TECHNICAL SPECIFICATIONS							
INDOOR UNITS				HSU-07LEA03	HSU-09LEA03	HSU-12LEA03	
DIMENSIONS	Unit	H	mm	265	265	265	
		W	mm	795	795	795	
		D	mm	182	182	182	
WEIGHT	Unit		kg	8.4	8.4	9.4	
COLOR	Unit	white					
SOUND LEVEL	Sound pressure (cooling)	high	dB(A)	37	37	39	
		medium	dB(A)	33	33	35	
		low	dB(A)	28	28	31	
	Sound power(cooling)	high	dB(A)	48	50	52	
FAN	Air flow rate(cooling)	high	m ³ /min	6.7	6.7	8.8	
		mid	m ³ /min	5.9	5.9	7.9	
		low	m ³ /min	5.1	5.1	7.5	
	Speed(cooling)	steps	3 Steps,Auto				
		high	rpm	1250	1250	1290	
		medium	rpm	1100	1100	1150	
		low	rpm	950	950	1000	
Type	Cross flow fan						
Motor output		W	15	20	20		
AIR FILTER	Removable/washable/mildew proof						
REMOTE CONTROLLER	YL-M10						
TEMPERATURE CONTROL	Microcomputer control						
PIPING CONNECTIONS(external diameter)	liquid	mm	Φ6.35	Φ6.35	Φ6.35		
	gas	mm	Φ9.52	Φ9.52	Φ12.7		
	drain	mm	Φ16	Φ16	Φ16		
INSULATION MATERIAL	Heat insulation type			both liquid and gas pipes			

TECHNICAL SPECIFICATIONS						
OUTDOOR UNITS				HSU-07LEA03	HSU-09LEA03	HSU-12LEA03
NET DIMENSIONS (stop valve, and bottom support is not included)	Unit	H	mm	428	428	543
		W	mm	261	261	255
		D	mm	700	700	783
WEIGHT	Unit		kg	24	25	32.5
COLOR	Unit	white				
SOUND LEVEL	Sound pressure(cooling)	high	dB(A)	48	50	52
	Sound power(cooling)	high	dB(A)	48	50	52
FAN	Air flow rate(cooling)	high	m ³ /min	17.6	17.4	28.2
		low	m ³ /min	---	---	---
	Speed(cooling)	high	rpm	860	850	870
		low	rpm	---	---	---
	Type	Propeller fan				
Motor output		W	22	26	30	
REFRIGERANT CIRCUIT	Refrigerant type	R22				
	Refrigerant charge		kg	0.55	0.49	0.78
	Maximum allowable distance between indoor and outdoor		m	7	7	10
	Maximum allowable level difference		m	5	5	5
	Refrigerant control	-----				
COMPRESSOR	Type	rotary Compressor				
	Model			44R213C	44R233CF-5JSC	PH215X2C-8FTC1
	Motor output		w	934.5	980	1180
	Oil type			SUNISO 4GSD	SUNISO 4GSD	SUNISO 4GSD
	Oil charge volume		L	0.27	0.27	0.52
PIPING CONNECTIONS	liquid		mm	Φ 6.35	Φ 6.35	Φ 6.35
	gas		mm	Φ 9.52	Φ 9.52	Φ 12.7
	drain		mm	Φ 16	Φ 16	Φ 16
INSULATION MATERIAL	Heat insulation type			both liquid and gas pipes		

ELECTRICAL SPECIFICATIONS						
For combination indoor units+outdoor units:				HSU-07LEA03	HSU-09LEA03	HSU-12LEA03
CURRENT	Nominal running current	cooling	A	4.0	4.3	5.7
	Maximum running current	cooling	A	4.9	5.7	7.5
	Starting current	cooling	A	10.8	21.5	25.3

For indoor units only:			HSU-07LEA03	HSU-09LEA03	HSU-12LEA03
POWER SUPPLY			VM	VM	VM
NOMINAL DISTRIBUTION SYSTEM VOLTAGE	Phase		1PH	1PH	1PH
	Frequency	Hz	50	50	50
	Voltage	V	220	220~240	220~240

NOTES

- 1 Nominal cooling capacities are based on: indoor temperature 27°CDB/19°CWB * outdoor temperature 35°CDB * refrigerant piping length: 5m * level difference: 0m.
- 2 Nominal heating capacities are based on: indoor temperature 20°CDB * outdoor temperature 7°CDB/6°CWB * refrigerant piping length 5m (horizontal) * level difference 0m.
- 3 Capacities are net, including a deduction for cooling (an addition for heating) for indoor fan motor heat.
- 4 Units should be selected on nominal capacity. Maximum capacity is limited to peak periods.
- 5 The sound pressure level is measured via a microphone at a certain distance from the unit. For measuring conditions: please refer to item 6 of this chapter.
- 6 The sound power level is an absolute value indicating the "power" which a sound source generates.
- 7 Energy label: scale from A (most efficient) to G (less efficient).
- 8 The energy label Directive 2002/31/EC will enter into force once the relevant measurement standard will be published in the European official Standard.
- 9 Annual energy consumption: based on average use of 500 running hours per year at full load (= nominal conditions)

3 Remote controller lists

Model	HSU-07LEA03	HSU-09LEA03	HSU-12LEA03
YL-M10	Y	Y	Y

4 Sensors lists

INDOOR UNIT		
type	Description	Qty
Room sensor	It's used for detecting room temperature	1
Pipe sensor	It's used for detecting temperature of evaporator	1

OUTDOOR UNIT		
type	Description	Qty
Ambient sensor	It's used for detecting temperature outdoor side	1
Suction sensor	It's used for detecting suction pipe temperature of compressor to adjust gas flowing	1
Defrosting sensor	It's used for controlling outdoor defrosting at heating mode	1
Discharging sensor	It's used for protecting compressor in case of over-heat	1

5 Dimensional drawings

Indoor uni65

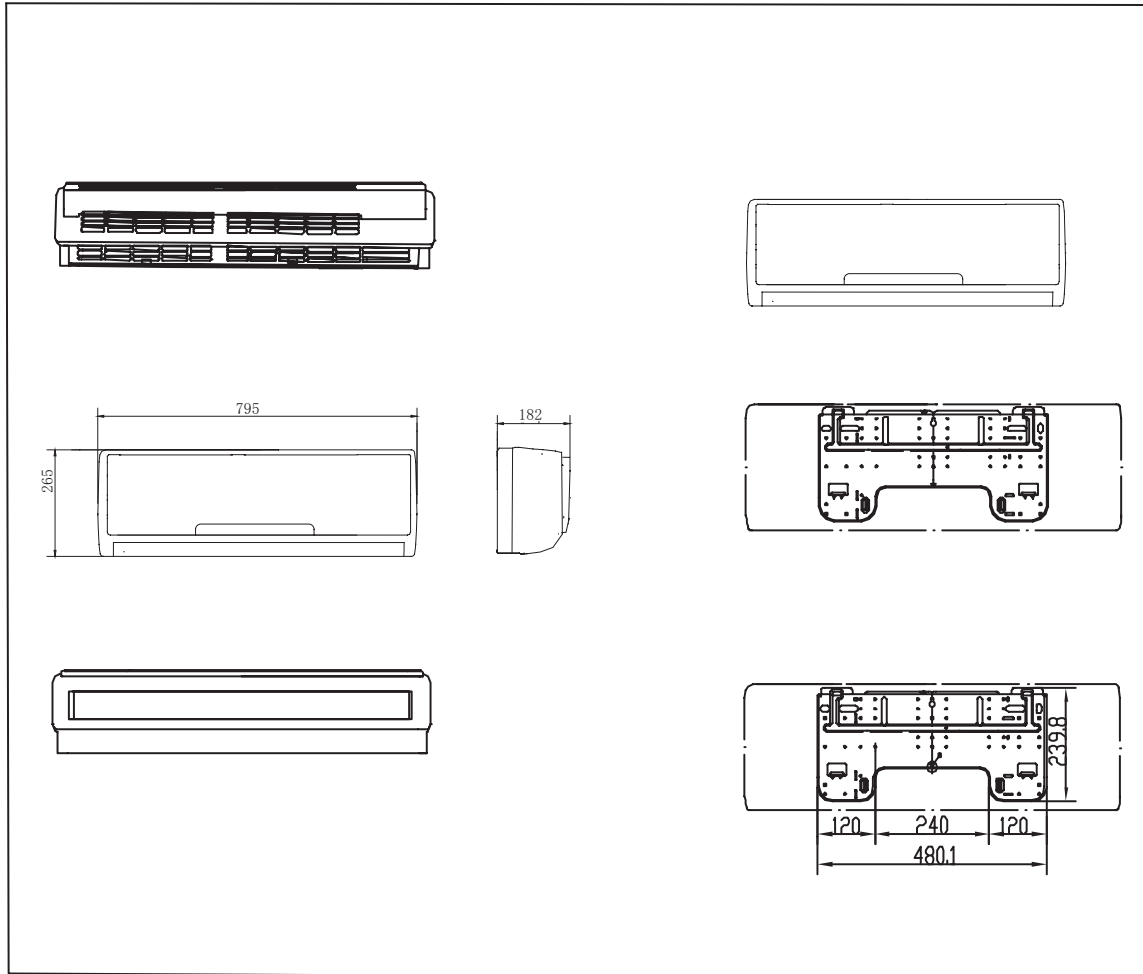

Outdoor unit

(1) HSU-07/09/12LEA03:

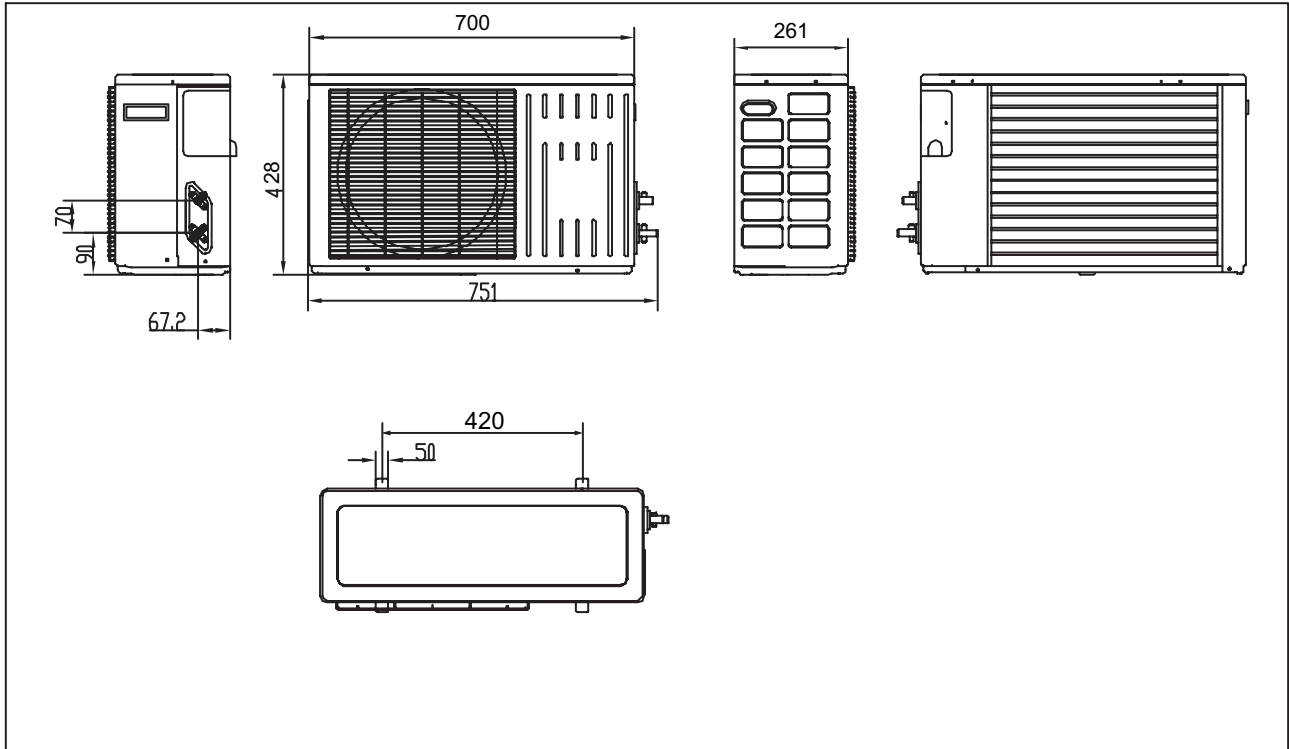

(2) HSU-12LEA03:

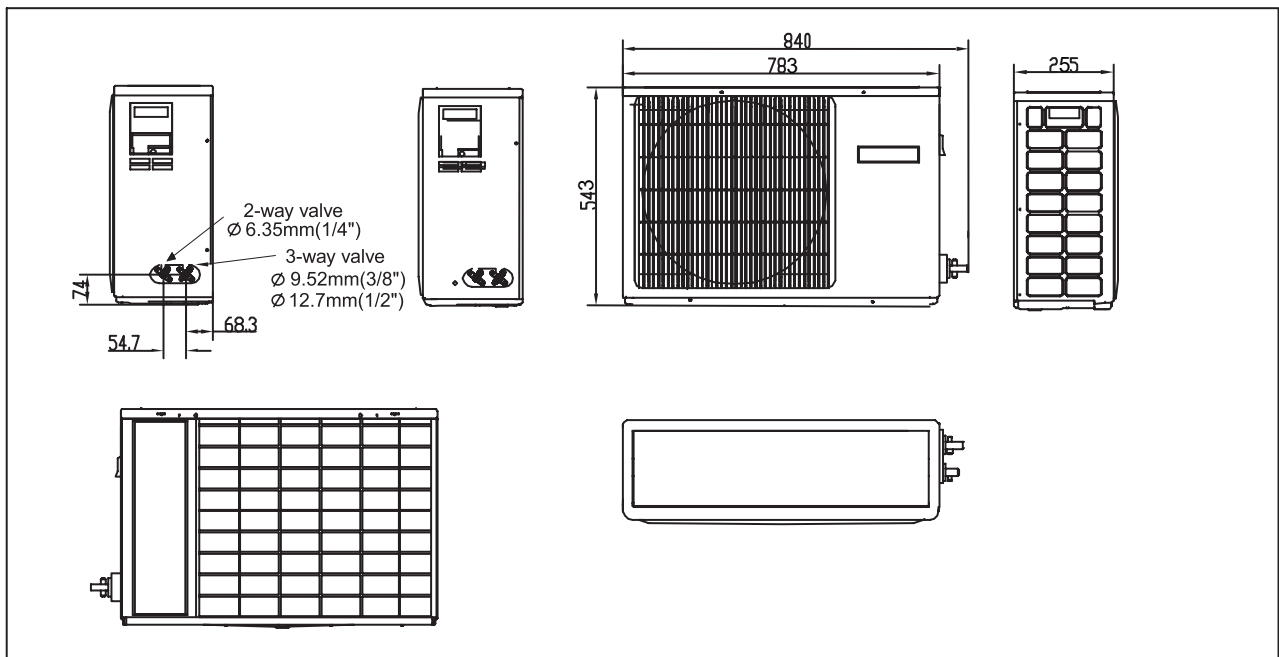

6 Operation range

Cooling

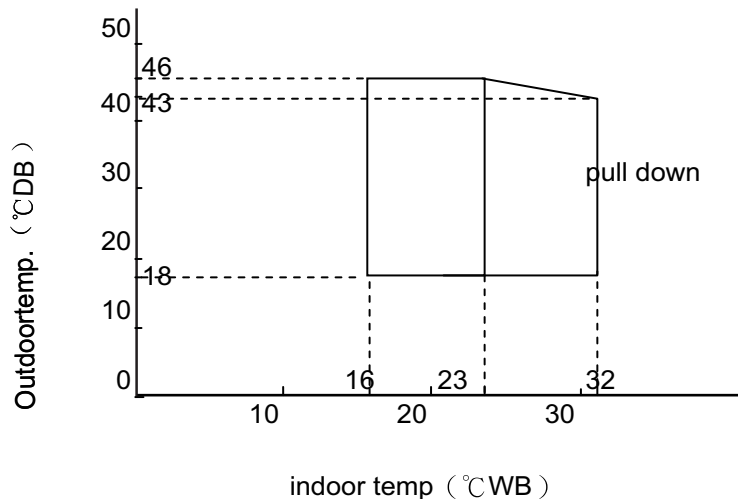

Heating

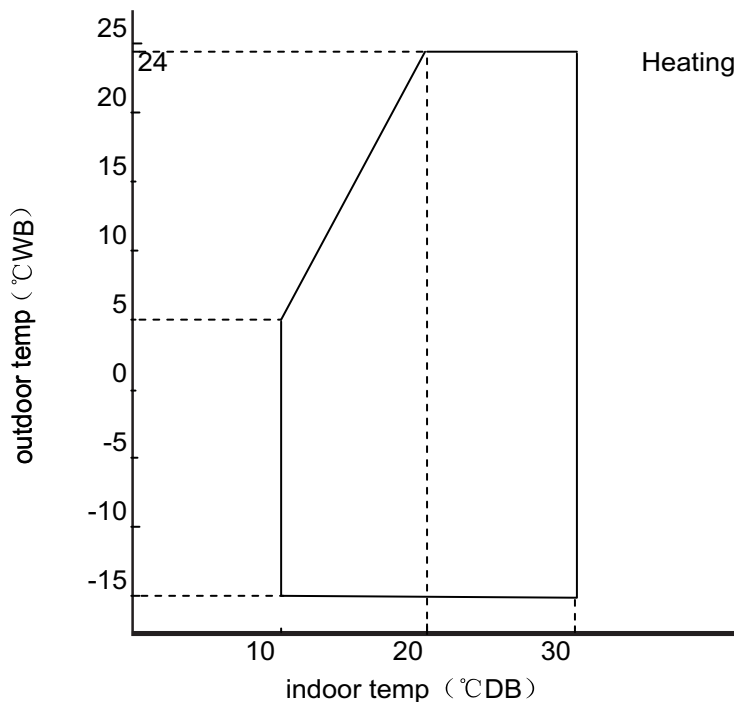

Notes:

The graphs are based on the following condition:
 Equivalent piping length 7.5m
 Level difference 0m
 Air flow rate high

7 Piping diagrams

Cooling mode

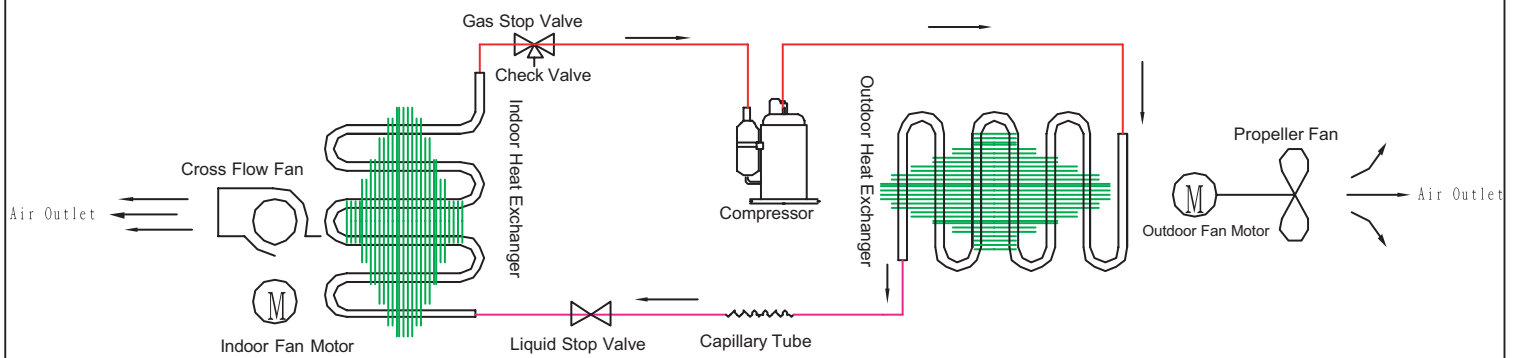

8 Wiring diagrams

Indoor unit (HSU-07LEA03):

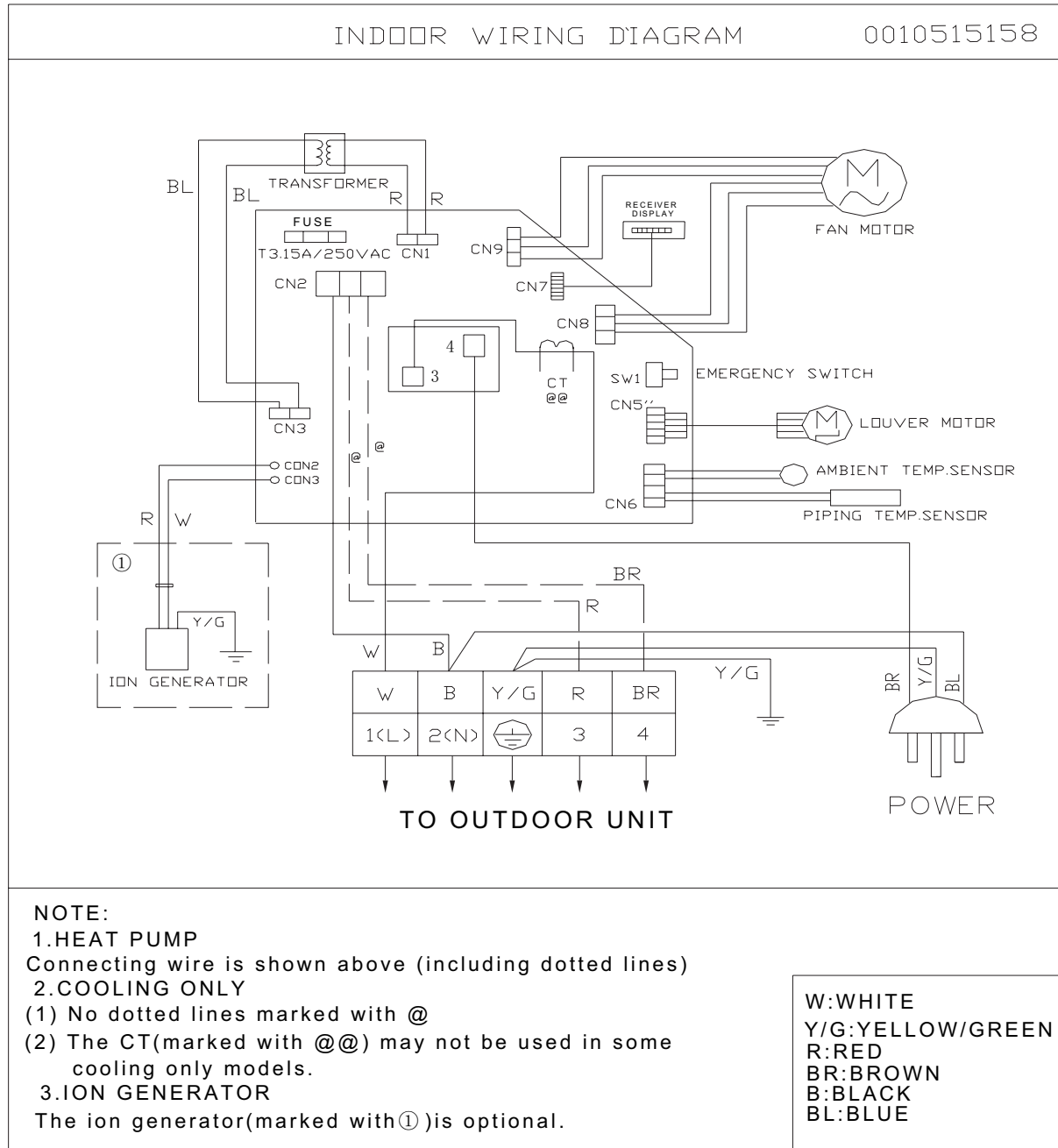

Indoor unit (HSU-09/12LEA03):

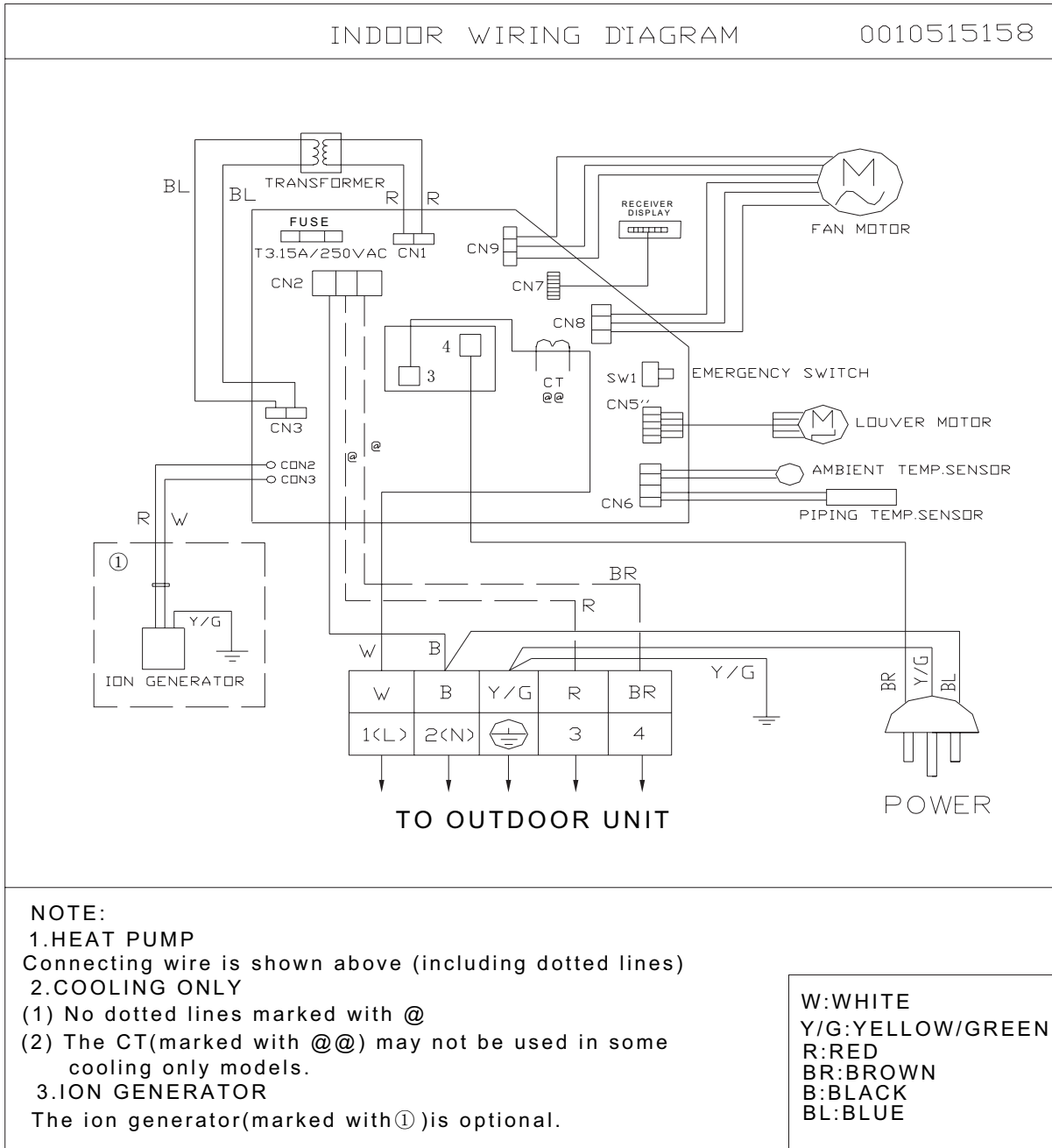

Outdoor unit(HSU-07/09LEA03):

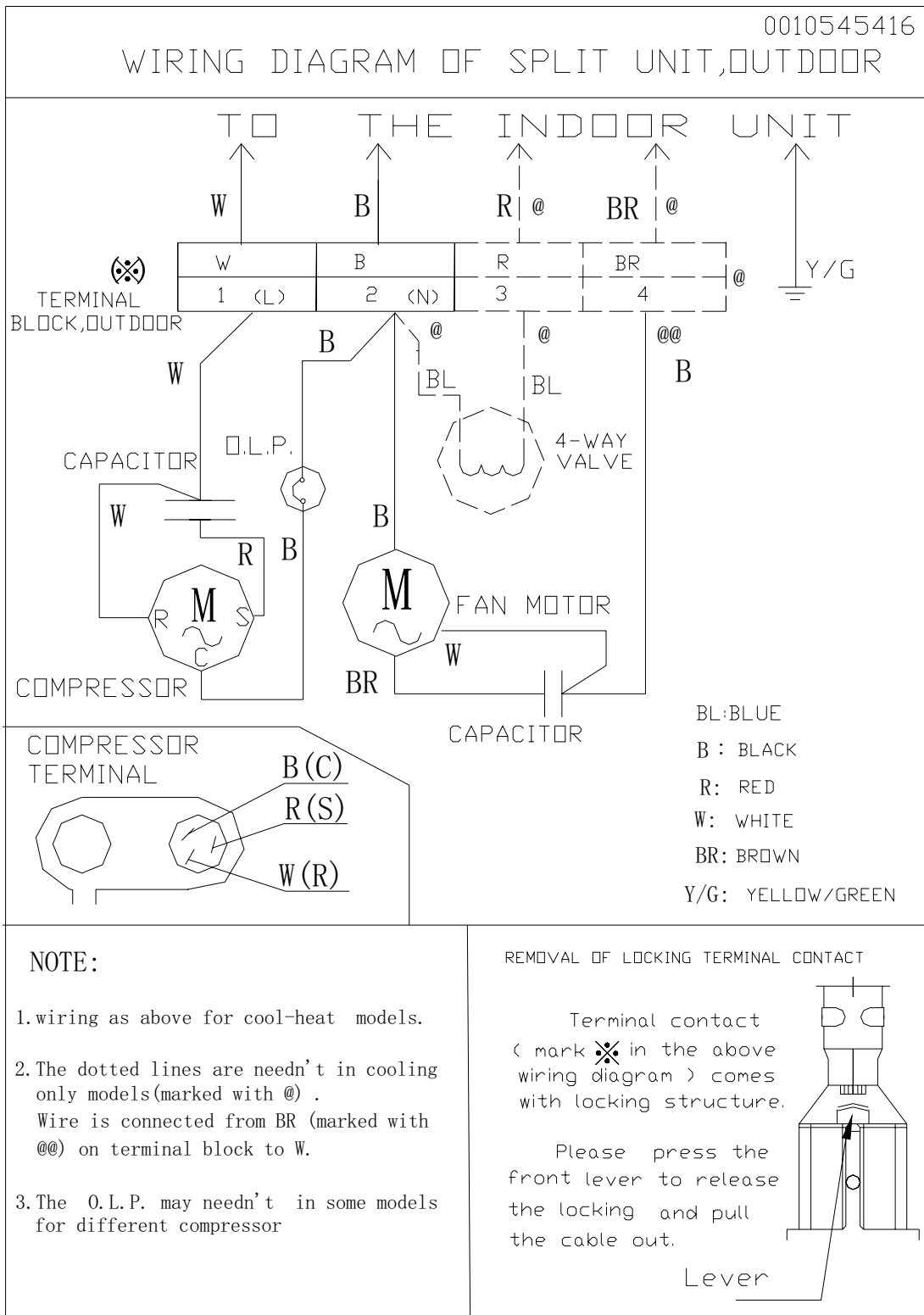

Outdoor unit (HSU-12LEA03):

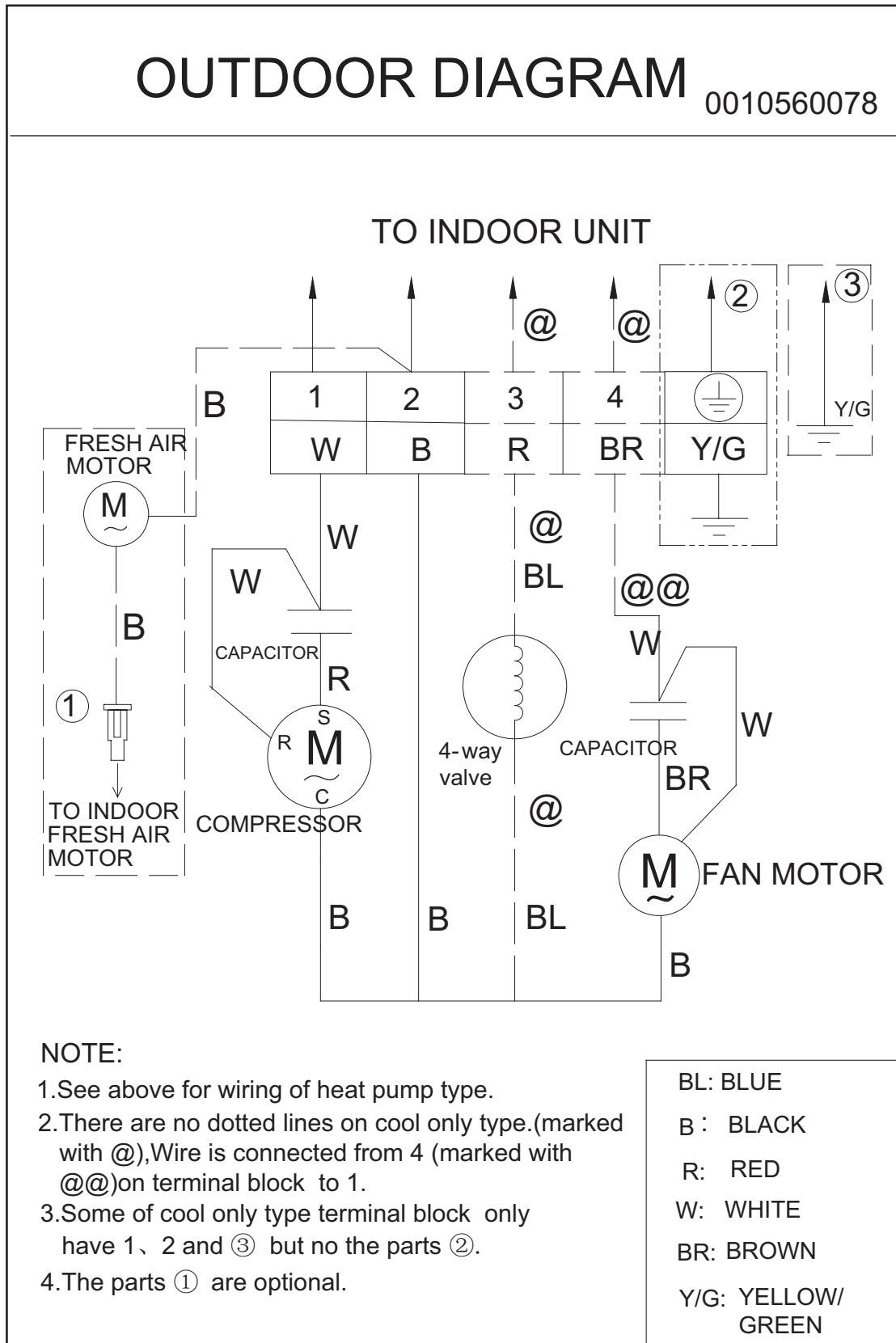

9. Capacity diagrams and curves diagrams

9.1 Cooling Capacity-temperature Curves

HSU-07LEA03 performance curves								
cooling value-temperature talbe								
indoor temp	outdoor temp.(humidity 46%)							
DB/WB	18°C	20°C	25°C	32°C	35°C	40°C	43°C	46°C
18/12°C	1566	1577	1587	1366	1376	1419	1269	1053
18/14°C	2049	2060	2127	1875	1838	1708	1596	1410
20/15°C	2531	2544	2557	2462	2300	2139	2003	1767
22/16°C	2477	2493	2510	2442	2267	2061	1922	1757
25/18°C	2424	2443	2462	2421	2234	2048	1925	1729
27/19°C	2685	2595	2645	2482	2380	2229	2106	1882
30/22°C	2962	2814	3002	2708	2578	2448	2276	2129
32/23°C	3062	2798	3008	2679	2622	2513	2385	2157
32/24°C	3141	2872	3086	2751	2693	2581	2450	2220

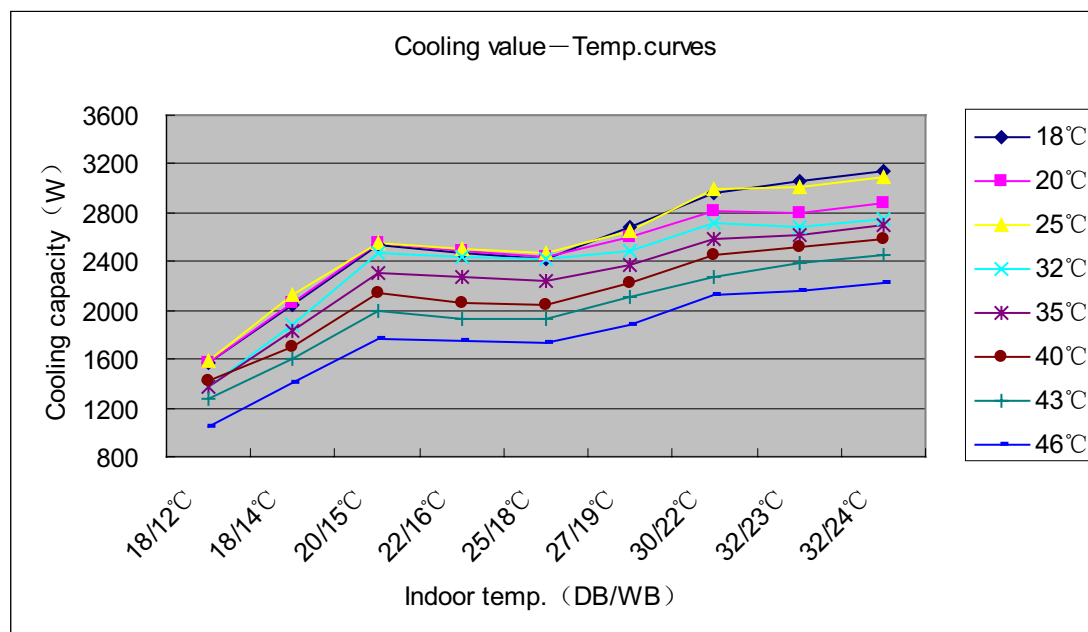

HSU-09LEA03 performance curves								
cooling value-temperature talbe								
indoor temp	outdoor temp.(humidity 46%)							
DB/WB	18°C	20°C	25°C	32°C	35°C	40°C	43°C	46°C
18/12°C	1686	1697	1707	1486	1496	1539	1389	1173
18/14°C	2169	2180	2247	1995	1958	1828	1716	1530
20/15°C	2651	2664	2677	2582	2420	2259	2123	1887
22/16°C	2597	2613	2630	2562	2387	2181	2042	1877
25/18°C	2544	2563	2582	2541	2354	2168	2045	1849
27/19°C	2805	2715	2765	2602	2500	2349	2226	2002
30/22°C	3082	2934	3122	2828	2698	2568	2396	2249
32/23°C	3182	2918	3128	2799	2742	2633	2505	2277
32/24°C	3261	2992	3206	2871	2813	2701	2570	2340

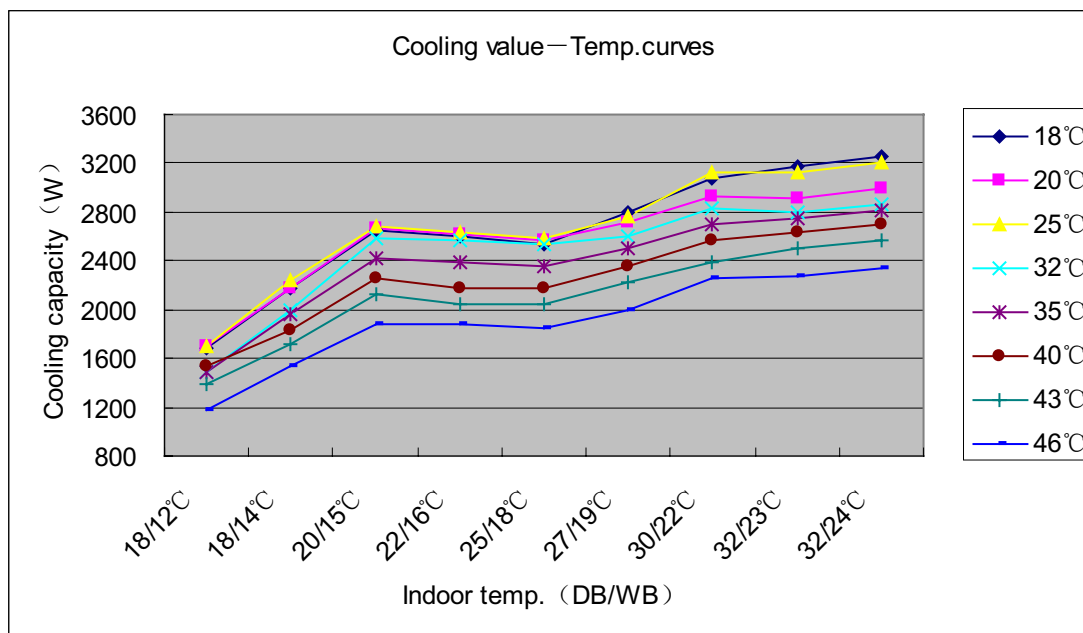

HSU-12LEA03 performance curves								
cooling value-temperature talbe								
indoor temp	outdoor temp.(humidity 46%)							
DB/WB	18°C	20°C	25°C	32°C	35°C	40°C	43°C	46°C
18/12°C	2686	2697	2707	2486	2496	2539	2389	2173
18/14°C	3169	3180	3247	2995	2958	2828	2716	2530
20/15°C	3651	3664	3677	3582	3420	3259	3123	2887
22/16°C	3597	3613	3630	3562	3387	3181	3042	2877
25/18°C	3544	3563	3582	3541	3354	3168	3045	2849
27/19°C	3805	3715	3765	3602	3500	3349	3226	3002
30/22°C	4082	3934	4122	3828	3698	3568	3396	3249
32/23°C	4182	3918	4128	3799	3742	3633	3505	3277
32/24°C	4261	3992	4206	3871	3813	3701	3570	3340

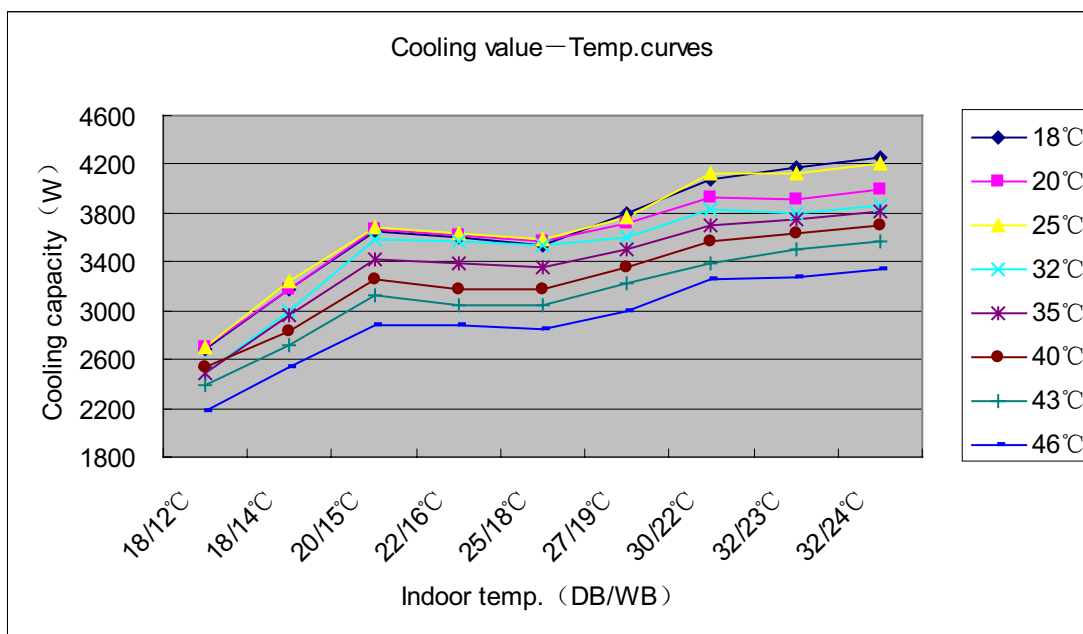

9.2 Cooling Power Consumption Value-temperature Curves

HSU-07LEA03 performance curves								
power consumption value-teme.talbe								
indoor temp.	outdoor temp.(humidity 46%)							
DB/WB	18°C	20°C	25°C	32°C	35°C	40°C	43°C	46°C
18/12°C	441	449	464	561	688	908	964	1019
18/14°C	515	523	540	647	787	1029	1090	1151
20/15°C	616	595	583	784	815	950	1027	1105
22/16°C	619	597	584	800	823	951	1030	1110
25/18°C	621	599	585	815	831	952	1033	1114
27/19°C	639	616	603	838	853	977	1060	1143
30/22°C	658	635	621	860	876	1002	1087	1172
32/23°C	664	627	600	819	855	1000	1097	1194
32/24°C	683	637	609	830	867	1013	1111	1209

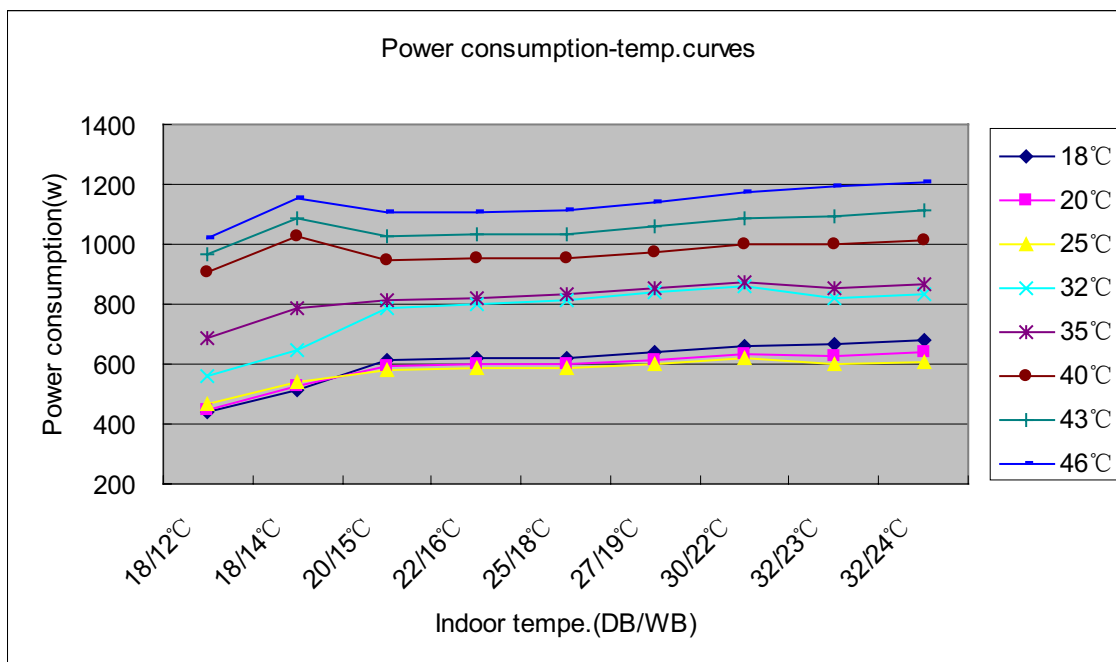

HSU-09LEA03 performance curves								
power consumption value-teme.talbe								
indoor temp.	outdoor temp.(humidity 46%)							
DB/WB	18°C	20°C	25°C	32°C	35°C	40°C	43°C	46°C
18/12°C	538	546	561	658	785	1005	1061	1116
18/14°C	612	620	637	744	884	1126	1187	1248
20/15°C	713	692	680	881	912	1047	1124	1202
22/16°C	716	694	681	897	920	1048	1127	1207
25/18°C	718	696	682	912	928	1049	1130	1211
27/19°C	736	713	700	935	950	1074	1157	1240
30/22°C	755	732	718	957	973	1099	1184	1269
32/23°C	761	724	697	916	952	1097	1194	1291
32/24°C	780	734	706	927	964	1110	1208	1306

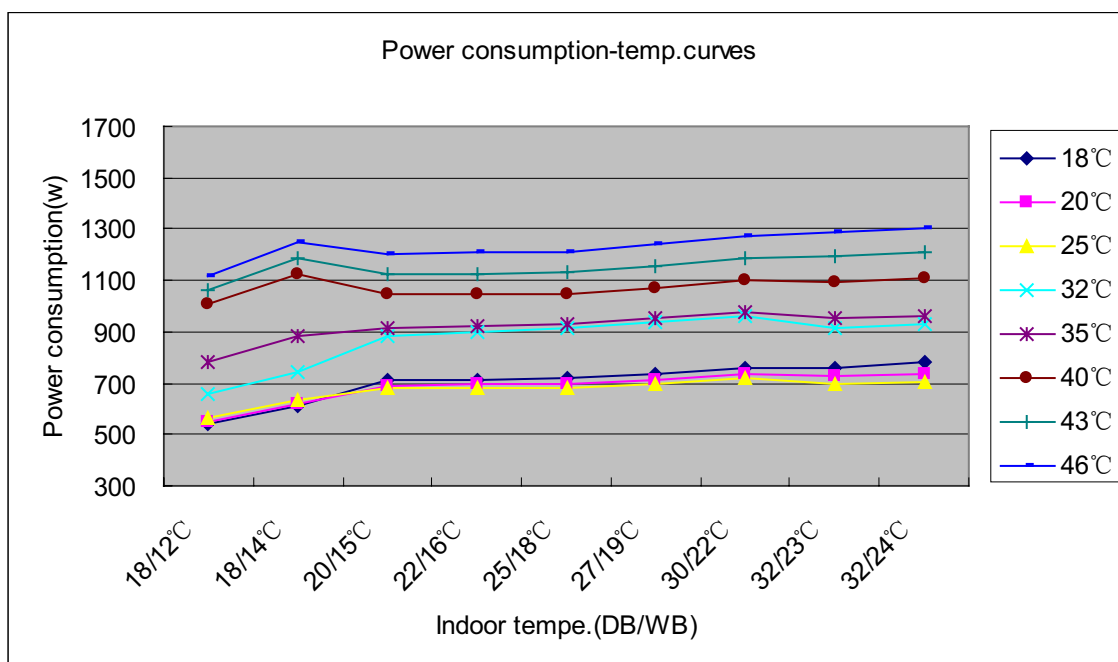

HSU-12LEA03 performance curves								
power consumption value-teme.talbe								
indoor temp.	outdoor temp.(humidity 46%)							
DB/WB	18°C	20°C	25°C	32°C	35°C	40°C	43°C	46°C
18/12°C	838	846	861	958	1085	1305	1361	1416
18/14°C	912	920	937	1044	1184	1426	1487	1548
20/15°C	1013	992	980	1181	1212	1347	1424	1502
22/16°C	1016	994	981	1197	1220	1348	1427	1507
25/18°C	1018	996	982	1212	1228	1349	1430	1511
27/19°C	1036	1013	1000	1235	1250	1374	1457	1540
30/22°C	1055	1032	1018	1257	1273	1399	1484	1569
32/23°C	1061	1024	997	1216	1252	1397	1494	1591
32/24°C	1080	1034	1006	1227	1264	1410	1508	1606

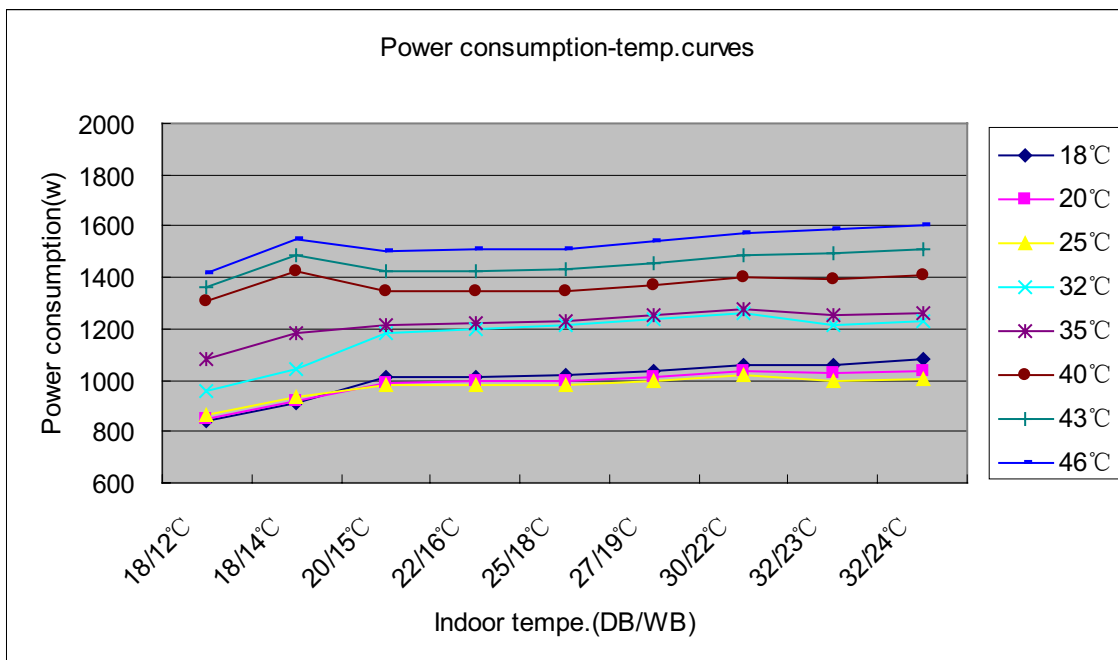

9.3 Cooling Suction Pressure Curves

HSU-07LEA03 performance curves			
cooling suction pressure table			
outdoor temp. (humidity 46%)	indoor temp.		
DB/WB	16°C	19°C	22°C
15°C	663	751	764
25°C	693	772	776
30°C	695	776	774
35°C	706	778	796
40°C	744	822	838
45°C	770	853	867

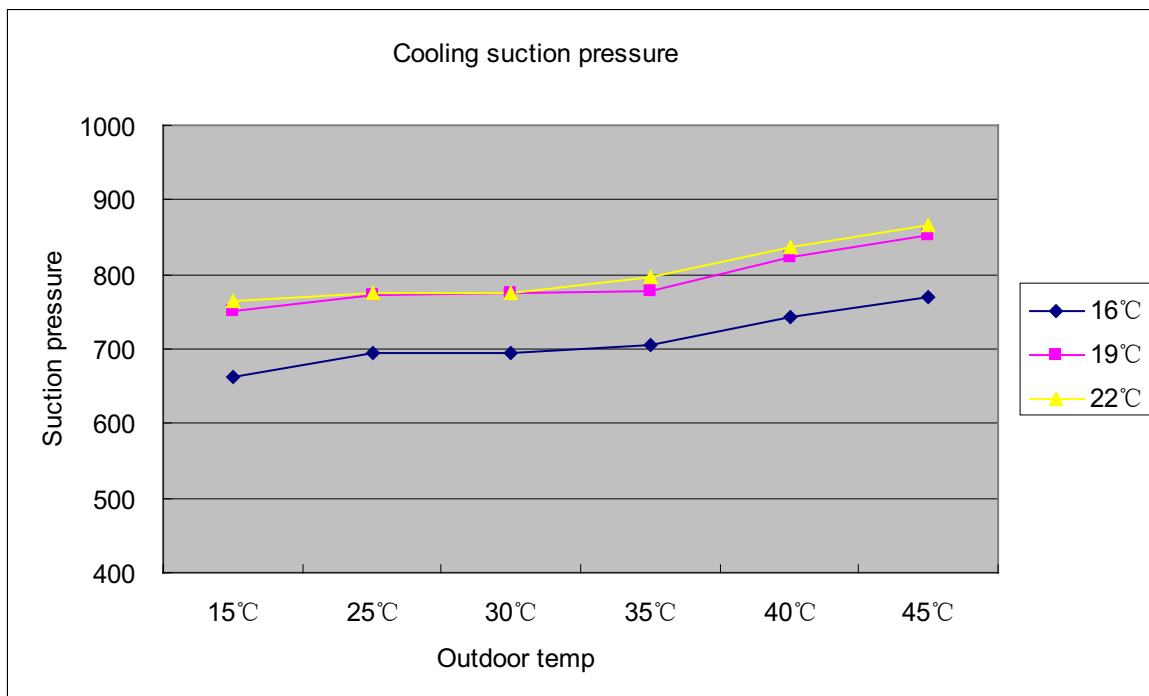

HSU-09LEA03 performance curves			
cooling suction pressure.talbe			
outdoor temp. (humidity 46%)	indoor temp.		
	16°C	19°C	22°C
DB/WB			
15°C	665	752	764
25°C	693	772	776
30°C	696	776	775
35°C	706	780	796
40°C	744	822	838
45°C	771	854	868

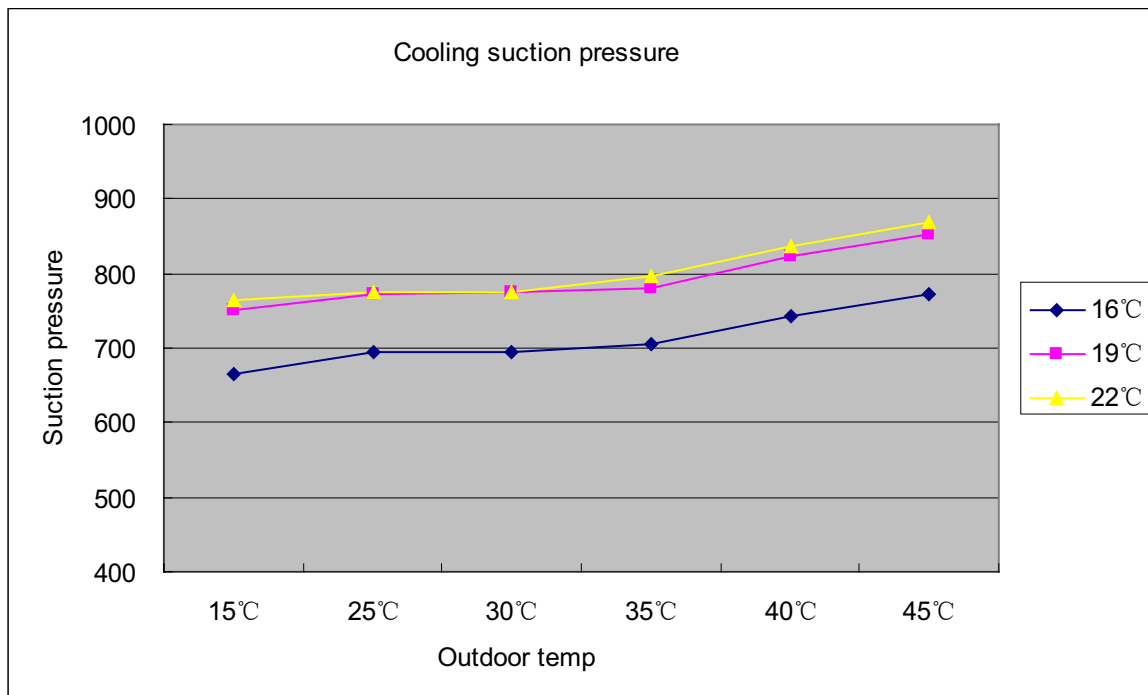

HSU-12LEA03 performance curves			
cooling suction pressure.tblbe			
outdoor temp. (humidity 46%)	indoor temp.		
DB/WB	16°C	19°C	22°C
15°C	667	752	766
25°C	693	774	778
30°C	696	776	775
35°C	706	780	796
40°C	744	822	838
45°C	773	856	869

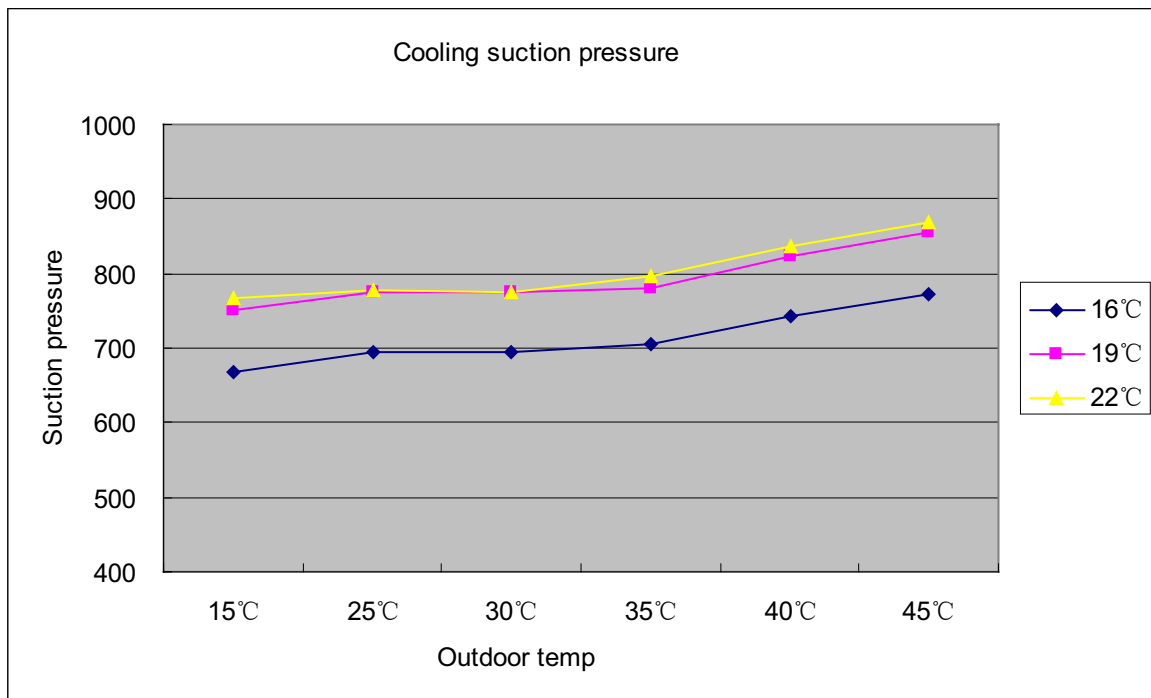

9.4 Sensible cooling capacity curves

HSU-07LEA03 performance curves								
sensible cooling value-temperature talbe								
indoor temp	outdoor temp.(humidity 46%)							
DB/WB	18°C	20°C	25°C	32°C	35°C	40°C	43°C	46°C
18/12°C	1096	1104	1111	956	963	993	888	737
18/14°C	1434	1442	1489	1313	1287	1195	1117	987
20/15°C	1772	1781	1790	1723	1610	1497	1402	1237
22/16°C	1734	1745	1757	1709	1587	1443	1345	1230
25/18°C	1697	1710	1723	1695	1564	1433	1347	1210
27/19°C	1879	1816	1851	1737	1666	1560	1474	1318
30/22°C	2073	1969	2102	1896	1805	1713	1593	1490
32/23°C	2143	1959	2105	1875	1836	1759	1669	1510
32/24°C	2199	2010	2160	1926	1885	1807	1715	1554

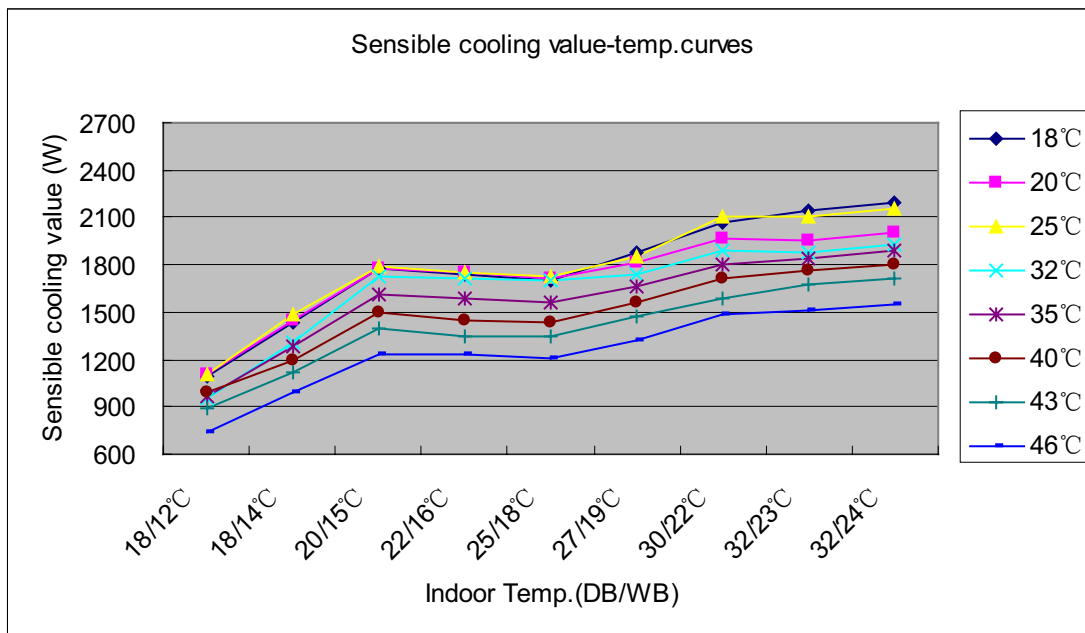

HSU-09LEA03 performance curves								
sensible cooling value-temperature talbe								
indoor temp	outdoor temp.(humidity 46%)							
DB/WB	18°C	20°C	25°C	32°C	35°C	40°C	43°C	46°C
18/12°C	1180	1188	1195	1040	1047	1077	972	821
18/14°C	1518	1526	1573	1397	1371	1279	1201	1071
20/15°C	1856	1865	1874	1807	1694	1581	1486	1321
22/16°C	1818	1829	1841	1793	1671	1527	1429	1314
25/18°C	1781	1794	1807	1779	1648	1517	1431	1294
27/19°C	1963	1900	1935	1821	1750	1644	1558	1402
30/22°C	2157	2053	2186	1980	1889	1797	1677	1574
32/23°C	2227	2043	2189	1959	1920	1843	1753	1594
32/24°C	2283	2094	2244	2010	1969	1891	1799	1638

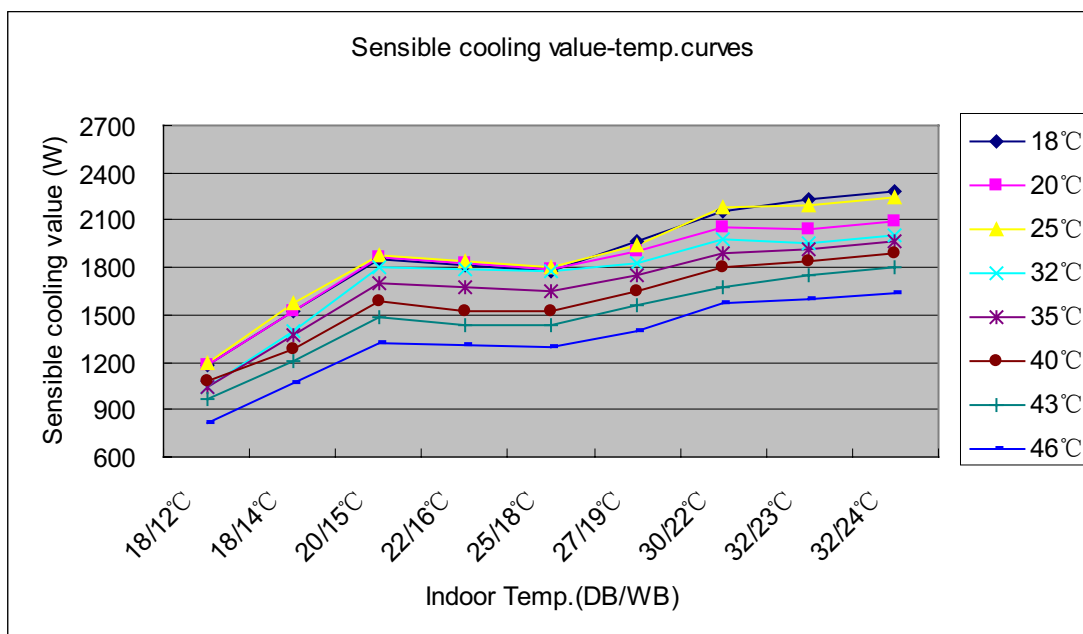

HSU-12LEA03 performance curves								
sensible cooling value-temperature talbe								
indoor temp	outdoor temp.(humidity 46%)							
DB/WB	18°C	20°C	25°C	32°C	35°C	40°C	43°C	46°C
18/12°C	1880	1888	1895	1740	1747	1777	1672	1521
18/14°C	2218	2226	2273	2097	2071	1979	1901	1771
20/15°C	2556	2565	2574	2507	2394	2281	2186	2021
22/16°C	2518	2529	2541	2493	2371	2227	2129	2014
25/18°C	2481	2494	2507	2479	2348	2217	2131	1994
27/19°C	2663	2600	2635	2521	2450	2344	2258	2102
30/22°C	2857	2753	2886	2680	2589	2497	2377	2274
32/23°C	2927	2743	2889	2659	2620	2543	2453	2294
32/24°C	2983	2794	2944	2710	2669	2591	2499	2338

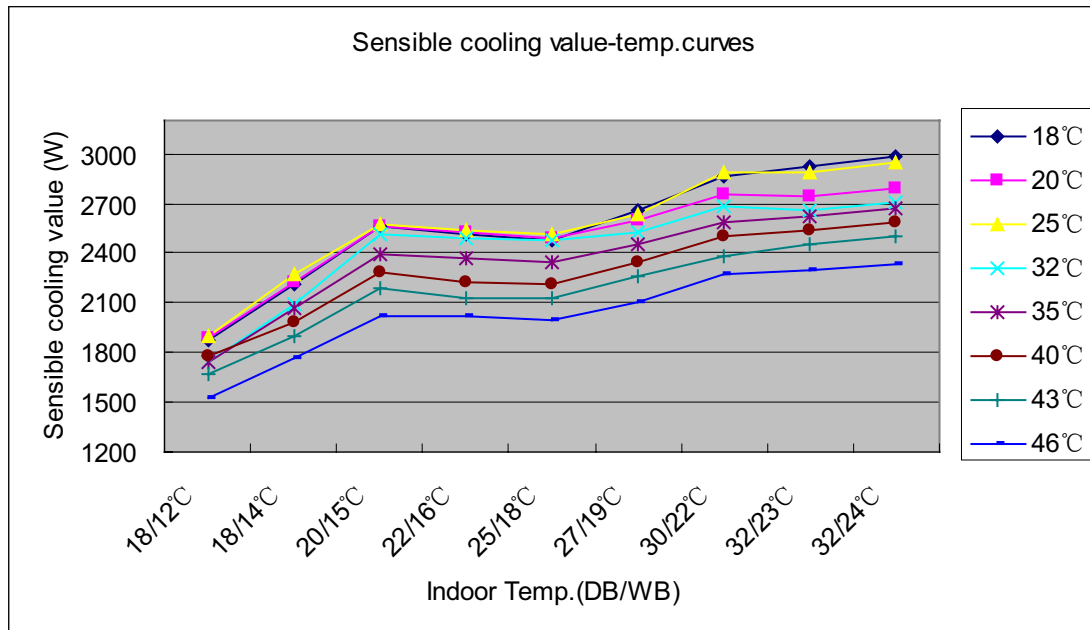

9.5 Air outlet temp. curves

HSU-07LEA03 performance curves								
air outlet temp.-ambient teme.talbe								
indoor temp	outdoor temp.(humidity 46%)							
DB/WB	18°C	20°C	25°C	32°C	35°C	40°C	43°C	46°C
18/12°C	4.80	4.70	4.47	5.31	5.24	5.30	5.81	6.17
18/14°C	5.25	5.16	4.90	5.83	5.77	5.81	6.36	6.78
20/15°C	9.08	8.97	8.54	9.04	9.64	10.32	10.65	10.97
22/16°C	9.32	9.20	9.05	9.31	9.91	10.60	10.99	11.29
25/18°C	9.56	9.44	9.25	9.57	10.19	10.89	11.33	11.61
27/19°C	11.25	11.10	10.89	11.28	12.10	12.82	13.35	13.69
30/22°C	13.17	13.12	13.06	13.68	14.18	14.78	15.15	15.33
32/23°C	15.07	15.17	15.24	16.07	16.36	16.74	16.95	16.97
32/24°C	15.36	15.47	15.53	16.40	16.69	17.07	17.28	17.31

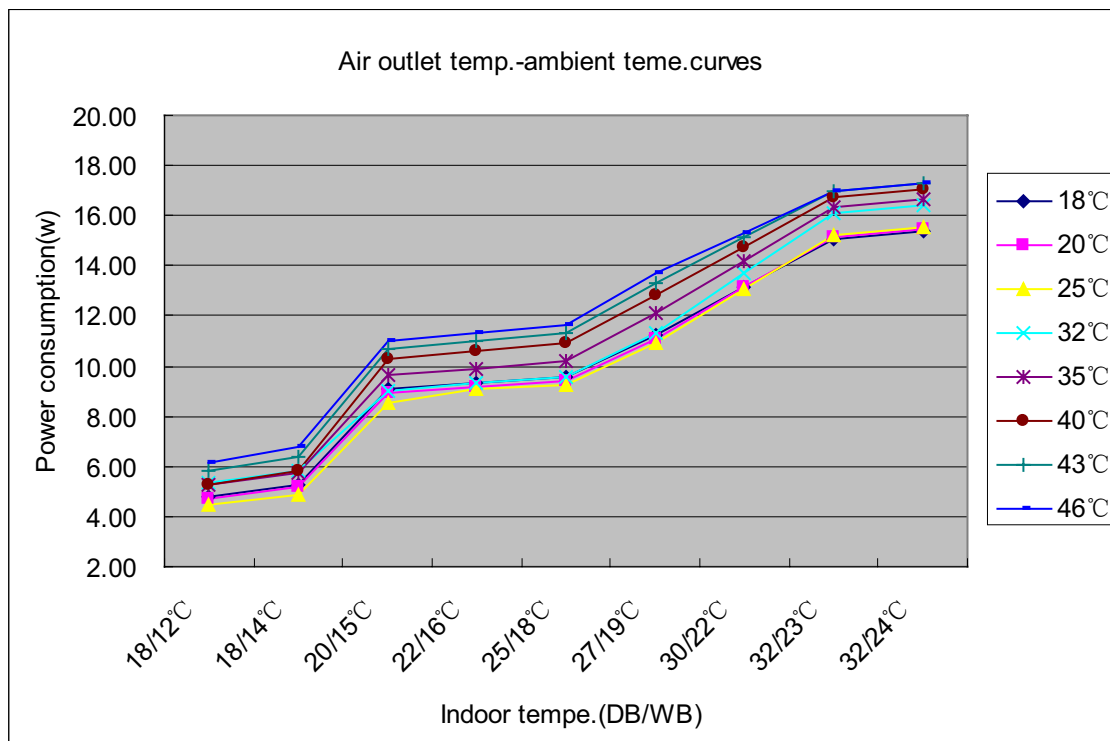

HSU-09LEA03 performance curves								
air outlet temp.-ambient teme.talbe								
indoor temp	outdoor temp.(humidity 46%)							
DB/WB	18°C	20°C	25°C	32°C	35°C	40°C	43°C	46°C
18/12°C	4.81	4.70	4.47	5.31	5.25	5.30	5.81	6.18
18/14°C	5.26	5.16	4.90	5.83	5.77	5.81	6.37	6.78
20/15°C	9.08	8.97	8.54	9.04	9.64	10.32	10.65	10.97
22/16°C	9.32	9.20	9.05	9.31	9.91	10.60	10.99	11.29
25/18°C	9.57	9.44	9.26	9.57	10.19	10.89	11.34	11.61
27/19°C	11.25	11.10	10.89	11.28	12.10	12.82	13.35	13.69
30/22°C	13.17	13.12	13.06	13.68	14.18	14.78	15.15	15.33
32/23°C	15.07	15.17	15.24	16.07	16.36	16.74	16.95	16.97
32/24°C	15.37	15.47	15.54	16.40	16.69	17.08	17.28	17.32

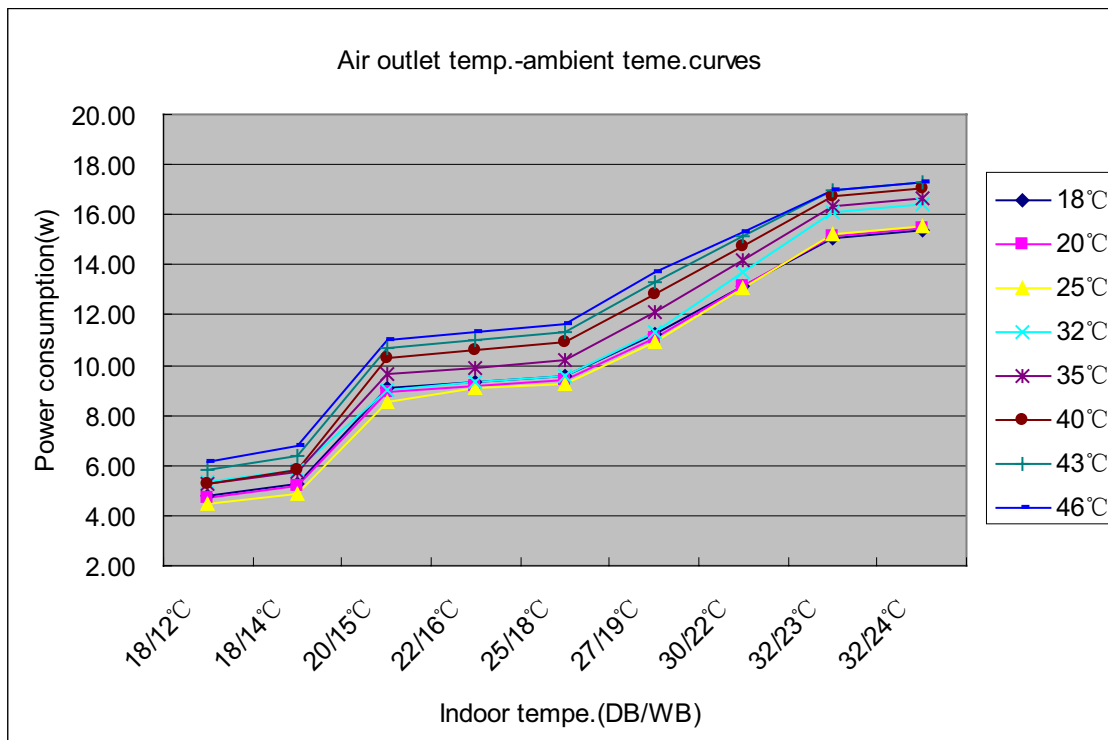

HSU-12LEA03 performance curves								
air outlet temp.-ambient teme.talbe								
indoor temp	outdoor temp.(humidity 46%)							
DB/WB	18°C	20°C	25°C	32°C	35°C	40°C	43°C	46°C
18/12°C	4.82	4.70	4.47	5.32	5.25	5.30	5.81	6.19
18/14°C	5.26	5.16	4.90	5.83	5.77	5.81	6.37	6.78
20/15°C	9.08	8.97	8.54	9.04	9.64	10.32	10.65	10.97
22/16°C	9.33	9.21	9.05	9.32	9.91	10.61	10.99	11.29
25/18°C	9.57	9.44	9.26	9.57	10.19	10.89	11.34	11.61
27/19°C	11.25	11.10	10.89	11.28	12.10	12.82	13.35	13.69
30/22°C	13.18	13.12	13.06	13.69	14.18	14.78	15.15	15.34
32/23°C	15.07	15.17	15.24	16.07	16.36	16.74	16.95	16.97
32/24°C	15.38	15.47	15.55	16.40	16.69	17.09	17.28	17.33

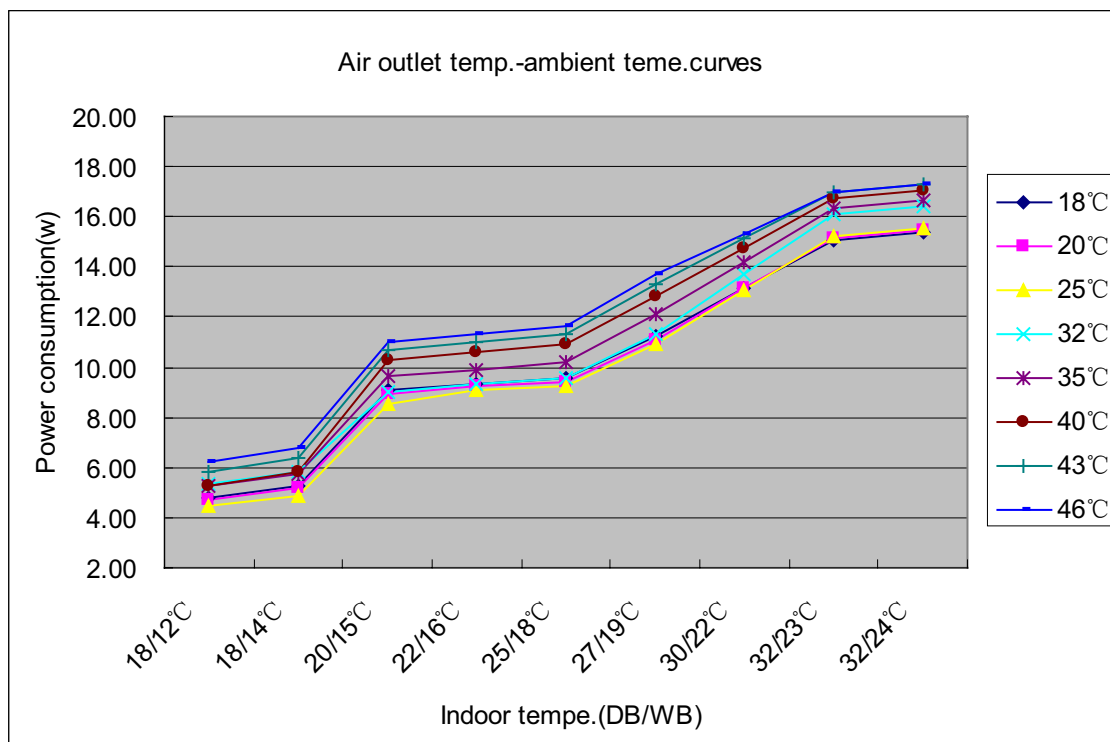

10 Sound level

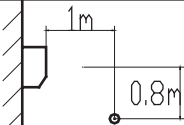
Model	Sound pressure level			Measuring location Location of microphone 	sound power level (cooling/heating)
	220V,50Hz				
	Cooling/heating				
	H	L	SL		
HSU-07LEA03	37	33	28		48

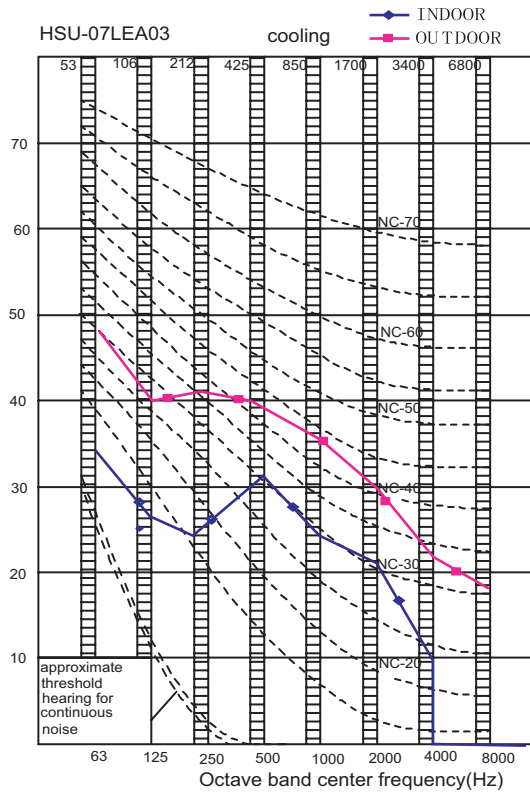

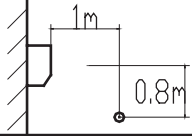
Model	Sound pressure level			Measuring location Location of microphone 	sound power level (cooling/heating)
	220~240V,50Hz				
	Cooling/heating				
	H	L	SL		
HSU-09LEA03	37	33	28		50
HSU-12LEA03	39	35	31		52

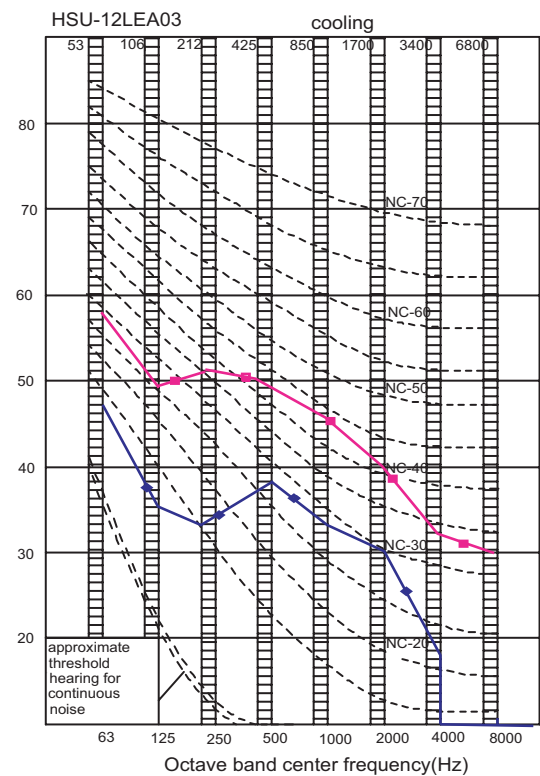
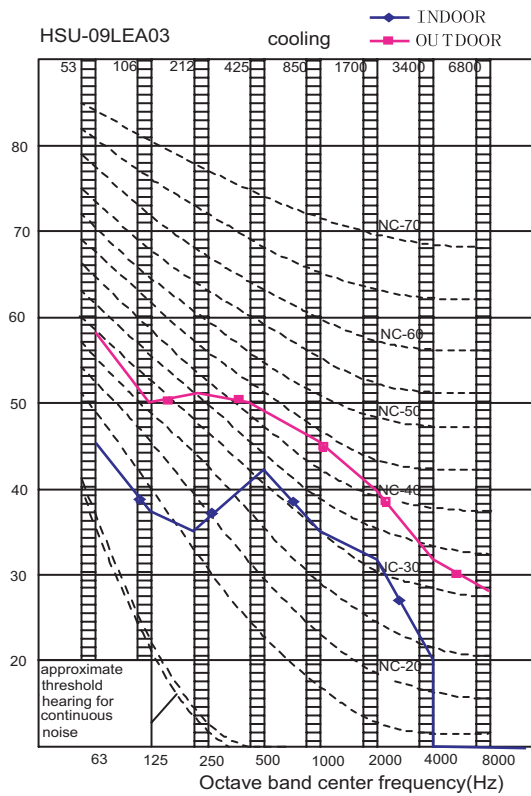

11 Accessories

Standard name	HSU-07LEA03	HSU-09LEA03	HSU-12LEA03
Drain hose	1	1	1
Plastic bag	1	1	1
screw assembly	1	1	1
Air purifier	1	1	1
Battery	1	2	2
Mounting plate	1	1	1
Remote controller	1	1	1
Installation manual	1	1	1
Operation manual	1	1	1

12 Control systems

If the unit which you purchased has not healthy function, Remote controller should like the following figure:

Remote controller

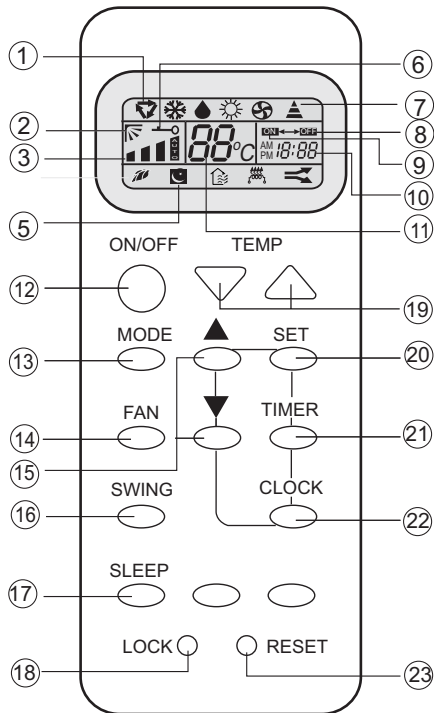

1. Operation mode display

Operation mode	AUTO	COOL	DRY	FAN
Remote controller				
Display board				

2. SWING display

3. FAN SPEED display

5. SLEEP display

6. LOCK display

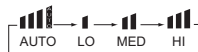

Display board

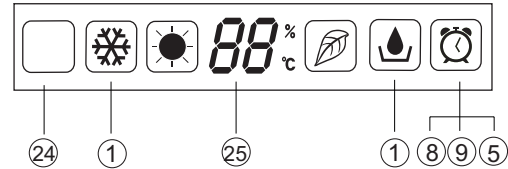

7. SIGNAL SENDING display

8. TIMER OFF display

9. TIMER ON display

10. CLOCK display

11. TEMP display

12. POWER ON/OFF

Used for unit start and stop.

13. MODE

Used to select AUTO run, COOL, DRY and FAN operation

14. FAN

Used to select fan speed LO, MED, HI, AUTO

15. HOUR

Used to set clock and timer setting.

16. SWING

Used to set auto fan direction.

17. SLEEP

Used to select sleep mode.

18. LOCK

Used to lock buttons and LCD display.

19. TEMP.

Used to select your desired temp.

20. SET

Used to confirm timer and clock settings.

21. TIMER

Used to select TIMER ON, TIMER OFF, TIMER ON-OFF

22. CLOCK

Used to set correct time

23. RESET

Used to reset the controller back to normal condition.

24. Singal receiver hole

25. Ambient temp.display

When receiving the remote control signal, display the set temperature and in the rest time the room temperature is displayed and this room temperature is only for reference.

Clock set

When unit is started for the first time and after replacing batteries in remote controller, clock should be adjusted as follows:

Press CLOCK button, "AM" or "PM" flashes.

Press Δ or ∇ to set correct time. Each press will increase or decrease 1min. If the button is kept depressed, time will change quickly.

After time setting is confirmed, press SET, "AM" and "PM" stop flashing, while clock starts working.

NOTE: Cooling only unit do not have displays and functions related with heating

Hints: After replacing with new batteries, remote controller will conduct self-check, displaying all information on LCD. Then, it will become normal.

13 Center of gravity

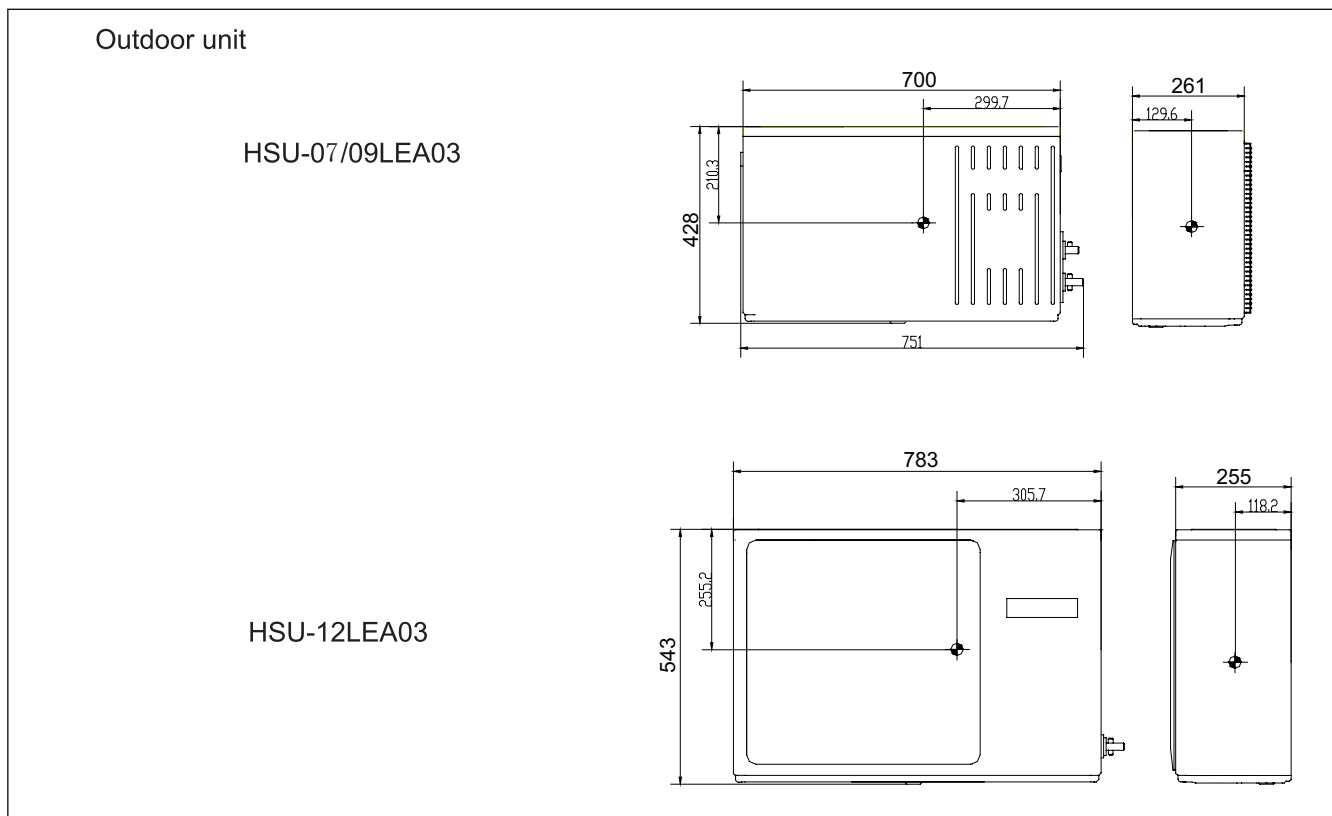
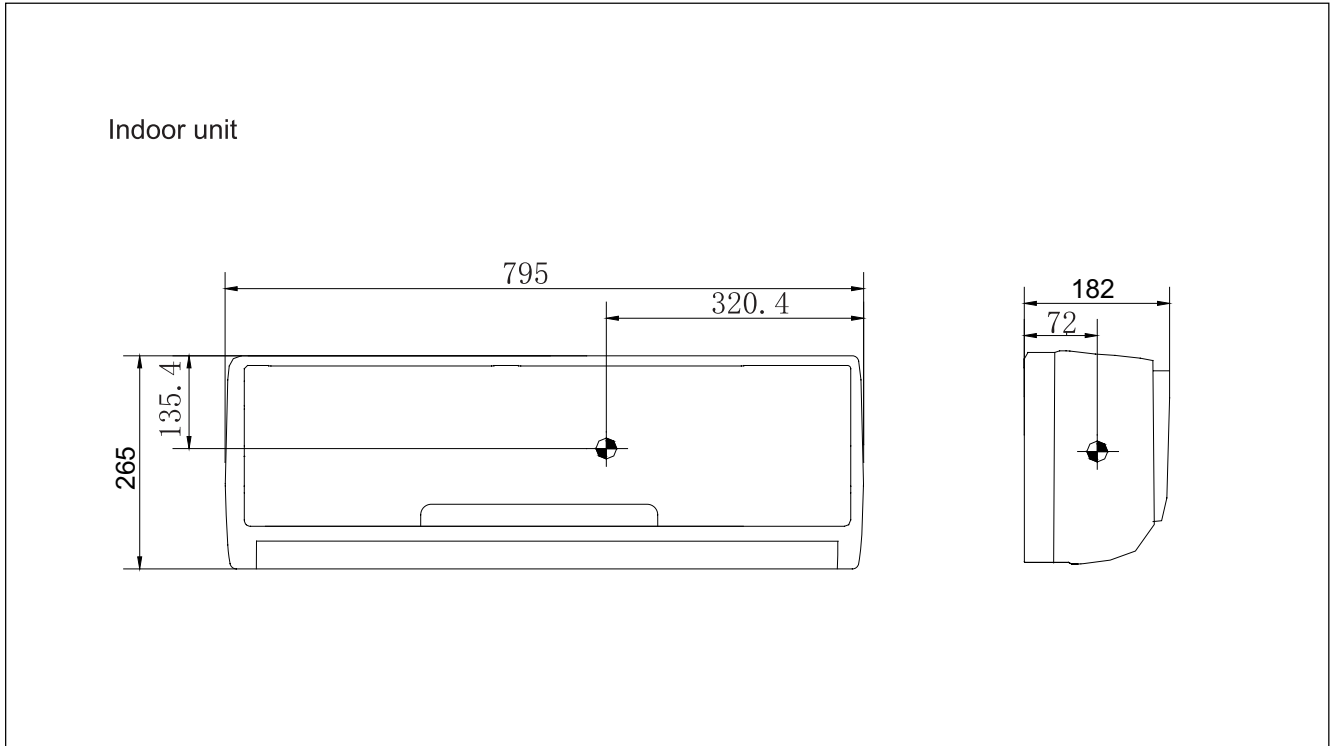

14 Installations

Indoor unit installation drawings

- How to attach the indoor unit.
Hook the claws of the bottom frame to the mounting plate.
If the claws are difficult to hook ,remove the front panel.
- How to remove the indoor unit.
Push up the marked area (at the lower part of the front panel) to release the the claws . If it is difficult to release ,remove the front panel .

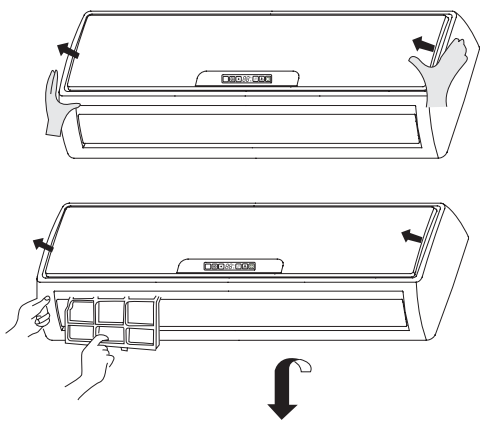
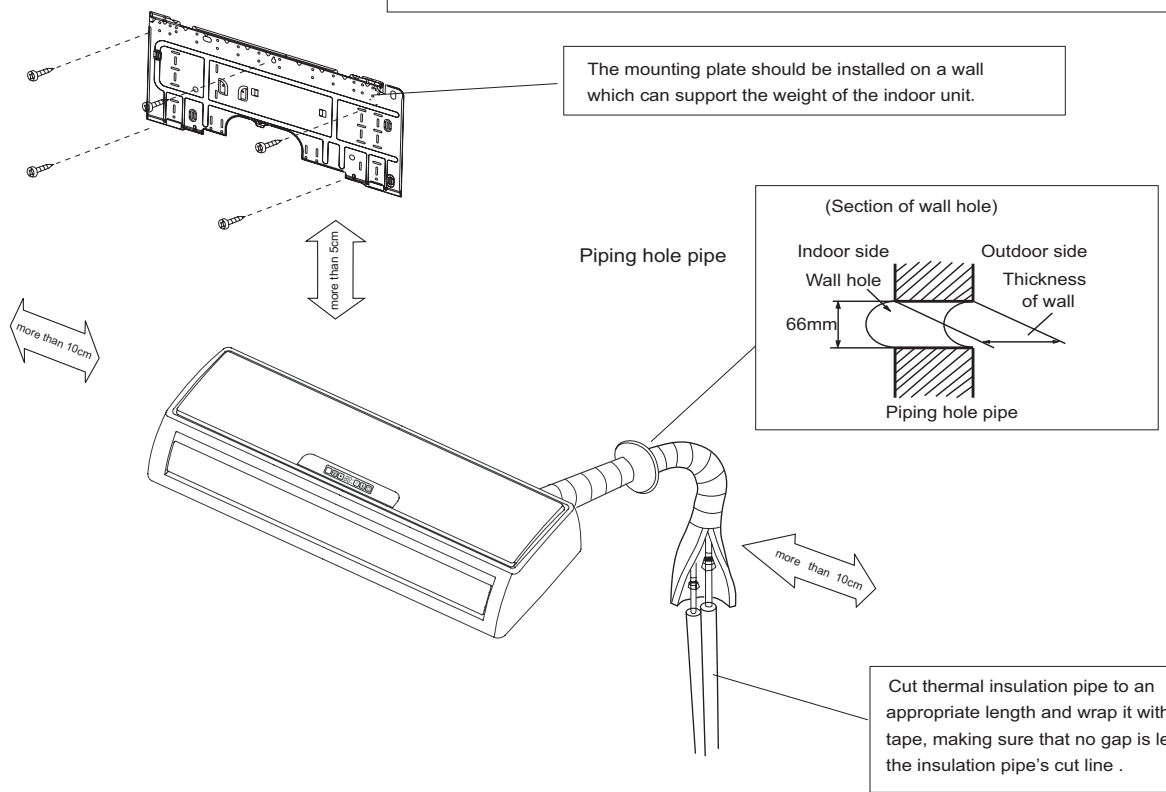

How to remove the air filter.

Open the inlet grille by pulling it upward.

Push up the filter's center tab slightly until it is released from the stopper, and remove the filter downward.

How to Attach the air filter.

Attach the filter correctly so that the "FRONT" indication is facing to the front. Make sure that the filter is completely fixed behind the stopper. If the right and left filters are not attached correctly, that may cause defects.

Close the inlet grille.

Outdoor unit installation drawings

HSU-07/09LEA03

Outdoor

Model	26 class
Max.allowable length	Cooling only: 7 m
Max.allowable height	5m
Additional refrigerant required for refrigerant pipe exceeding 5m in length	20 g/m
Gas pipe	O.D. 9.52
Liquid pipe	O.D. 6.35

*Be sure to add the proper amount of additional refrigerant. Failure to do so may result in reduced performance.

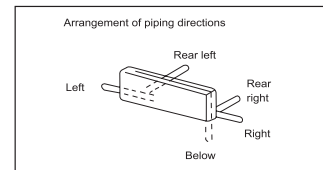

The distance between the indoor unit and the floor should be more than 2m.

Wrap the installation pipe with the finishing tape from bottom to top Model 25 / 35 class

Service lid

- How to remove the service lid. This service lid is an open/close type. Slide the lid downward to remove it.
- How to attach the service lid. Insert the upper part of the service lid into the outdoor unit to install. Tighten the screws.

Where there is a danger of the unit falling, use foot bolts, or wires.

- Fix the unit to concrete or block with bolts(Φ10mm) and nuts firmly and horizontally.
- When fitting the unit to wall surface, roof or rooftop, fix a supporter surely with nails or wires in consideration of earthquake and strong wind.
- If vibration may affect the house, fix the unit by attaching a vibration-proof mat.

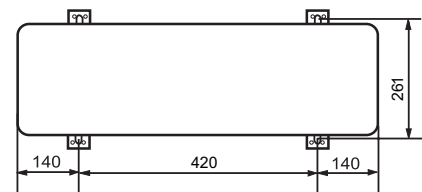

Outdoor unit installation drawings

HSU-12LEA03

Outdoor

Model	28 class
Max.allowable length	Cooling only 10 m
Max.allowable height	5 m
Additional refrigerant required for refrigerant pipe exceeding 5m in length	20 g/m
Gas pipe	O.D.6.35
Liquid pipe	O.D.12.7

*Be sure to add the proper amount of additional refrigerant. Failure to do so may result in reduced performance.

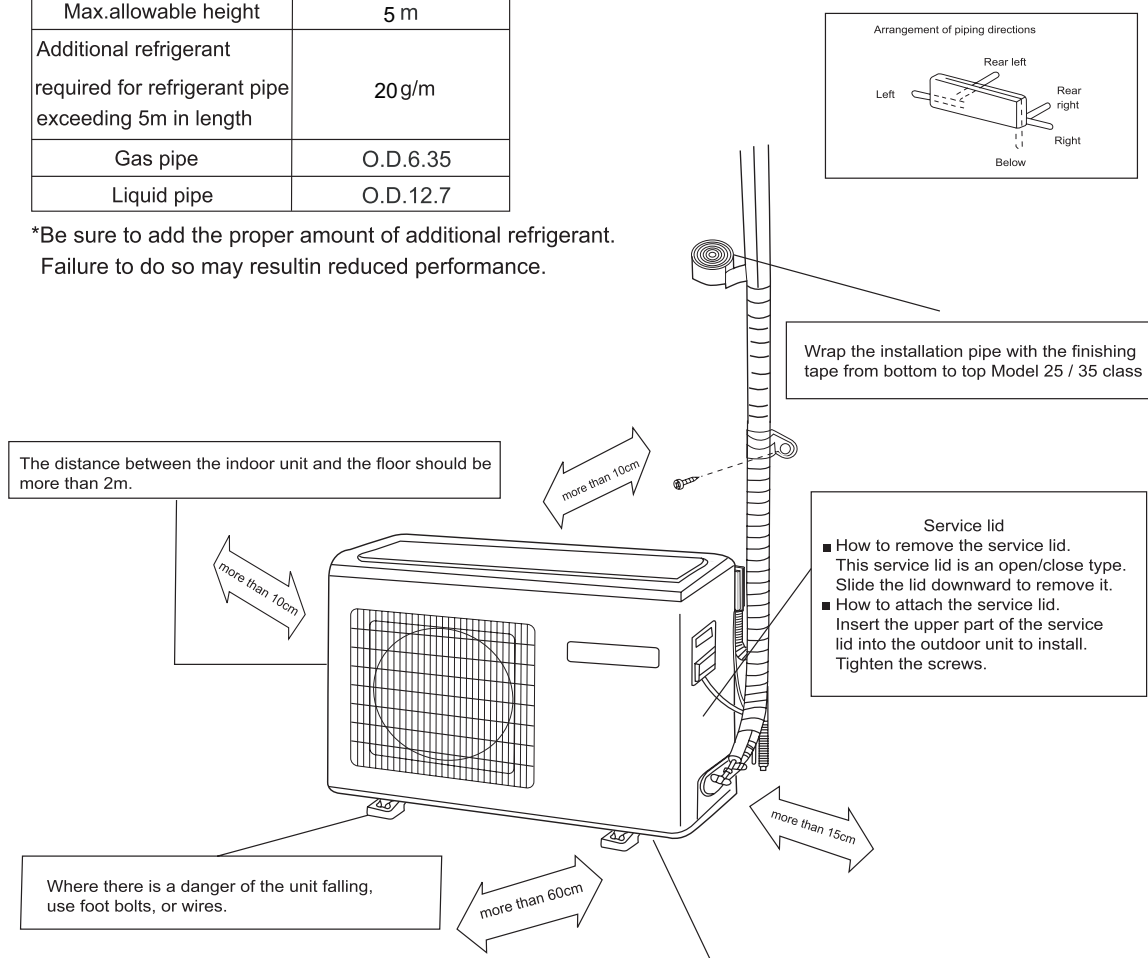

- Fix the unit to concrete or block with bolts ($\varnothing 10\text{mm}$) and nuts firmly and horizontally.
- When fitting the unit to wall surface, roof or rooftop, fix a supporter surely with nails or wires in consideration of earthquake and strong wind.
- If vibration may affect the house, fix the unit by attaching a vibration-proof mat.

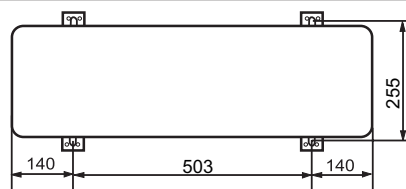

Sincere Forever



Haier Group

Haier Industrial Park, No.1, Haier Road

266101, Qingdao, China

E-mail:

Tel: +86 532 87636960

Http://www.haier.com

Edited by:TAO.LIU

JINGLONG.LIU

Signed by:BIFEI.YANG

Approved by:HONGJIN.WU